

RETINAL CAMERA

---

---

Kowa **VX-20**

---

---

**INSTRUCTION MANUAL**



KOWA VX-20

US





# Introduction

Accept our congratulations on your purchase of KOWA VX-20.

KOWA VX-20 is a retinal camera which is capable of mydriatic and non-mydriatic photography.

This manual provides a description of the operation procedures of KOWA VX-20 and important precautions to be observed during its use.

Please read this manual carefully to assure that the instrument can demonstrate its full capabilities and work safely. After you have finished reading, keep this manual in an easily accessible location near the instrument for future reference.



## Operational considerations for safety

This manual describes important precautions to be observed when you use this system to assure that the system is used safely without causing any damage to the human body or property of the purchaser and other persons.



The designations and pictorial symbols used in this manual have the following meanings.

These should be fully comprehended before reading the text of this manual.

### Meanings of designations

	<b>Warning</b>	If the instrument should be operated wrongly, there may incur a risk of causing death or serious injury.
	<b>Caution</b>	If the instrument should be operated wrongly, there may result in a bodily injury <sup>*1</sup> or damage to property <sup>*2</sup> .
<p>*1 A bodily injury means an injury, burn, electrical shock and so forth that will not necessitate hospitalization or long-term outpatient treatment.</p> <p>*2 Damage to property means an extensive damage to a house and/or household goods as well as a domestic animal and pet.</p>		

### Meanings of symbols





	Graphical indication of any danger (including warning and caution). What is warned is explicitly and pictorially indicated by a picture or its associated message on or near a pictorial symbol.
	Graphical indication of prohibited operation (prohibitive item). What is prohibited is explicitly and pictorially indicated by a picture or its associated message on or near a pictorial symbol.
	Graphical indication of any mandatory action (obligatory item). What must always be done is explicitly and pictorially indicated by a picture or its associated message on or near a pictorial symbol.

### Disclaimer

Kowa is not responsible for:

- Any damage caused by fire, earthquake, third party's action, any other accident or user's intentional or unintentional error, abuse or use under abnormal conditions.
- Any damage resulting from use of the product or its malfunction (e.g. operating loss, shutdown, change/loss of stored data and so forth).
- Any damage resulting from disobedience of what is described in this manual.
- Any damage resulting from, for instance, malfunctioning of instrument caused by a combination of connected devices.

## ⚠ Warning

 Unplug	<p>If any abnormal smell, sound, overheating or smoke should be detected, be sure to turn OFF the main power immediately and then unplug the instrument from the power outlet. Continued use of the instrument may cause the instrument to malfunction or cause a fire. Contact Kowa or your Kowa dealer for inspection immediately.</p>	
	 Warning High-Voltage	<p>When replacing the flash lamp and observation lamp, make sure the instrument is turned OFF and then unplugged from the power outlet. Wait for more than 5 minutes, or more than 30 minutes if immediately after use, before replacing. Otherwise, there may occur electrical shock.</p>
	<p>When replacing the fuse, make sure the instrument is turned OFF and unplugged from the power outlet. If the fuse holder cover is removed with the instrument unplugged, there may occur electrical shock.</p>	
 Obligatory	<p>Be sure to plug into the power outlet completely and securely. Otherwise, there may cause a fire or electrical shock.</p>	
	<p>Use a designated fuse only. Otherwise, the instrument may malfunction or a fire may break out.</p>	
	<p>Make sure that the instrument is properly grounded to protect from bodily injury. Connect the plug into the three-wire grounding type outlet with ground wire. Otherwise, there may occur electrical shock.</p>	
 Prohibitory	<p>Do not place a container or cup containing liquid near the instrument. Spilled liquid entering into the instrument may cause electrical shock. If liquid should be spilled into the instrument, turn OFF the main power and then unplugged from the power outlet. Contact Kowa or your Kowa dealer for inspection.</p>	
	<p>Do not load the power outlet or cable with excess of its rated capacity. If the main power cable should share a power outlet with other devices and the rated capacity is exceeded, there may cause a fire or electrical shock.</p>	
	<p>Do not insert any metal object into an air vent or opening of the instrument. It may cause an instrument malfunctioning, fire or electrical shock.</p>	
 Disassembly prohibited	<p>Do not disassemble, modify or repair the instrument yourself. It may cause a fire, electrical shock, instrument malfunctioning or bodily injury. Refer all servicing to Kowa or your Kowa dealer. The product assembled by yourself will not be covered under warranty nor any other service.</p>	

## ⚠ Caution



Obligatory

The power supply must be provided for the sole use of this instrument. Sharing a same power supply with other devices may cause malfunctioning.

When operating the instrument, take good care so that the patient's eye, nose or face does not come in contact with the instrument.

When moving up or down the chin rest to adjust the height of the patient's eyes, carefully manipulate the instrument while checking the position of the patients' head. A patient with the smaller head may get his or her head caught between the components.

Handle the flash lamps and halogen lamps and fuses made of glass with good care.



Prohibitory

Do not pull the power supply cable when unplugging. Doing so may damage the cable and cause a fire or electrical shock. Be sure to hold the plug when unplugging.

Do not plug or unplug the power supply cable with wet hand. Otherwise, there may occur electrical shock.

Do not install the instrument at unstable location such as on a shaky base or a tilting surface. Doing so may cause the instrument to drop or fall over and result in a bodily injury.



Do not replace the flash lamp and halogen lamp immediately after turning the OFF the main power. You could be burned by the lamp heated to a high temperature. Wait for more than 30 minutes to cool the lamp down before replacing.

Do not touch the flash lamp bulb and halogen lamp bulb with your bare hand. Otherwise, the lamp may reduce the light intensity and longevity.

Do not increase the observation illumination light intensity more than required. Otherwise, the eye may be injured.

Do not increase the photography light intensity more than required. Otherwise, the patient may experience pain and his or her eye may be injured.

The air vent must not be obstructed. Obstructing the air vent may increase the internal temperature resulting in malfunctioning of the instrument or a fire.

Do not insert any metal object into an air vent or opening of the instrument. It may cause electrical shock and malfunctioning of the instrument.

When operating this instrument, keep your fingers off the gap between the optical head base and panning arm or the tilting arm and tilting component, or the gap of the panning arm. Otherwise, the fingers may be pinched and injured. Instruct the patient not to place his or her fingers on the instrument.

Do not wipe the outer surface of the instrument with solvents such as benzene, organic solvent, ether. Doing so may cause discoloration or degradation.

Instruct the patient not to place his or her fingers on the instrument except for the grips (optional accessory). Otherwise, the fingers may be pinched and injured.

Do not use a sharp object to perform touch operation on the LCD monitor. It may cause malfunctioning of the instrument.

Do not apply excess force when performing touch operation on the LCD monitor. The optical component may move unexpectedly, resulting in an injury.

## Caution for fingers location

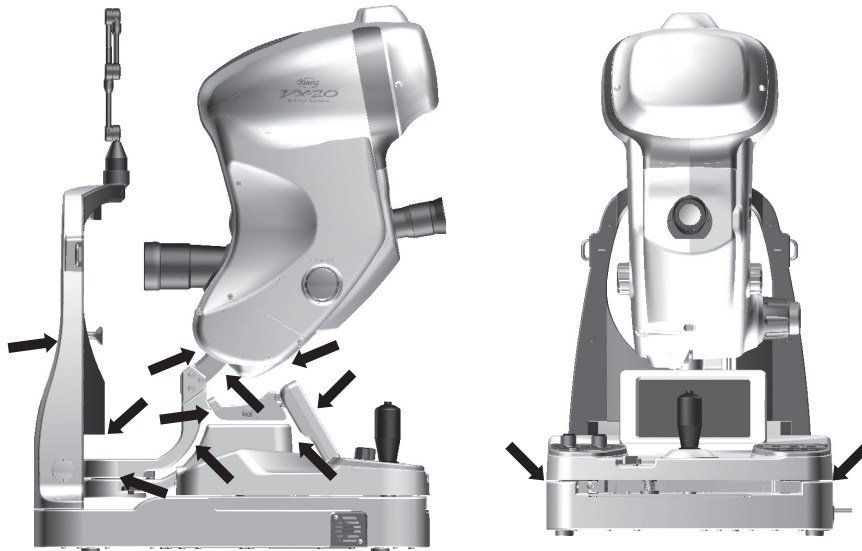

### Caution

Keep your fingers off the location shown with the arrows in the illustration when operating this instrument. Otherwise, the fingers may be pinched and injured. Instruct the patient not to place his or her fingers on the instrument.

## Caution for contact



### Caution

Take good care so that the patient's eye, nose or face does not come in contact with the locations shown with an arrow in the illustration when operating the instrument.

## Caution for air vent





### Caution



The air vent shown with the arrows in the illustration must not be obstructed. Obstructing the air vent may increase the instrument temperature and resulting in malfunction of the instrument or a fire. Do not insert any metal object into an air vent or opening of the instrument, also. It may cause electrical shock and malfunctioning of the instrument.

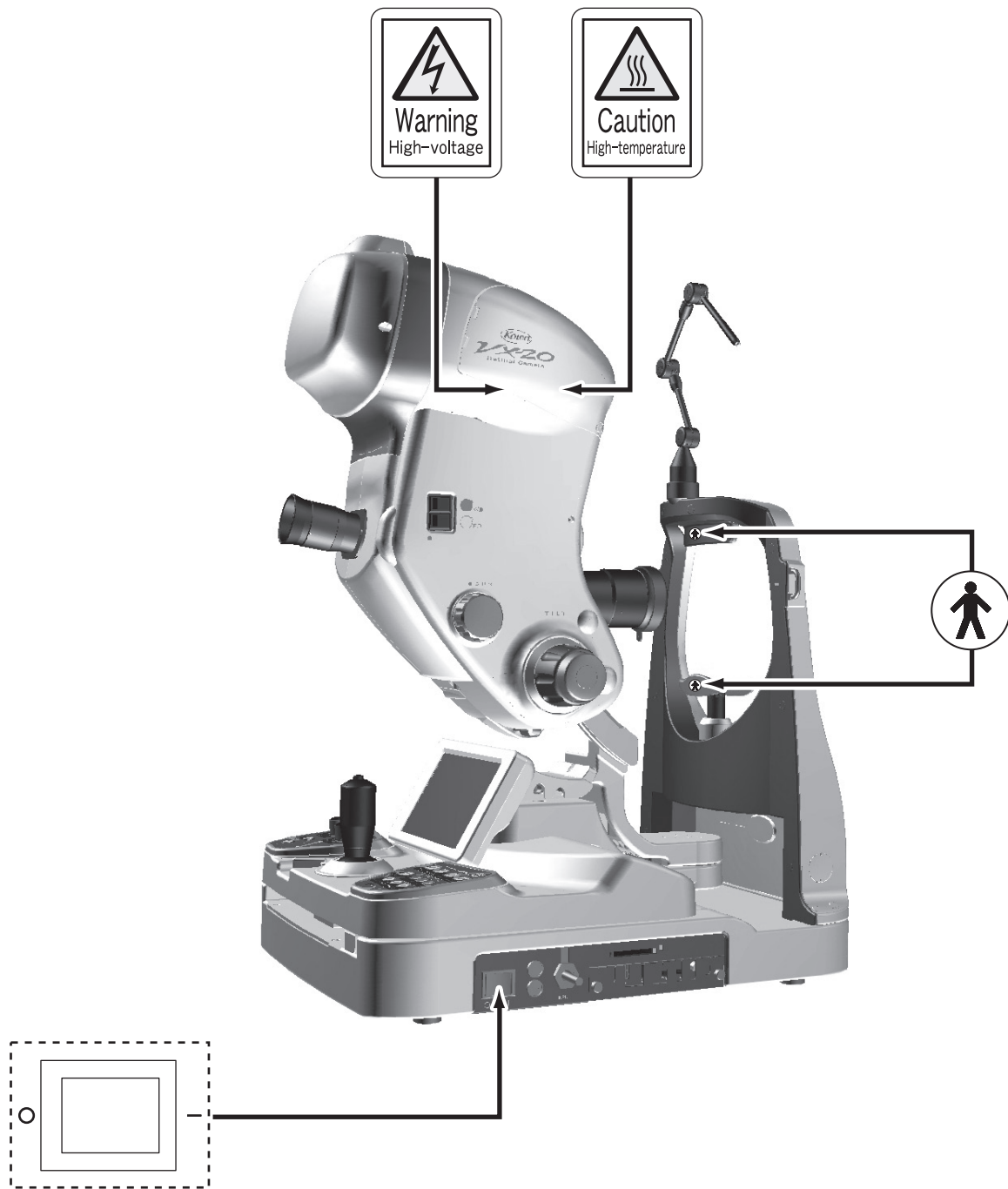

# Meanings of symbols



	Symbol for "Power ON".
○	Symbol for "Power OFF".
	Symbol for "Type B applied part".

	Symbol for "Caution".
	Symbol for "Warning High-voltage".
	Symbol for "Caution High-temperature".

# Operating precautions

## 1. Operating environment

- 1) Instrument should be operated only by qualified and trained personnel.
- 2) Handle the instrument with care, and do not apply strong shock to the instrument.
- 3) Avoid high temperature and humidity, direct sunlight, and dust when installing and storing the instrument. Strictly observe the following environmental conditions.

	Operating	Transporting and storing
Environmental temperature	10 to 35 °C	-15 to +55 °C
Relative humidity	30 to 90 %	10 to 95 %

- 4) Avoid condensation when using, transporting or storing the instrument.
- 5) Do not connect a digital camera other than that supplied with this instrument. Using other camera may adversely affect the safety or performance of this instrument.
- 6) Install the instrument in a room where the lighting is 5 lux or less which you may barely manage to read a newspaper.

## 2. Precautions on electric system

- 1) When the instrument has not been used for a long period of time, inspect the items below.
  - Inspect if the objective lens is free from soils.
  - Inspect if intensity of the lamps appropriately adjustable.
- 2) Install the system in a location where there is little risk of the plug being pulled out while operating. If the plug should be pulled out accidentally, be sure to turn OFF the main power before plugging the system back in.
- 3) Kowa is not liable for malfunctions and/or damages resulting from maintenance and/or repairs performed by the third party other than an agent authorized by Kowa.
- 4) Kowa is not liable for malfunctions and/or damages resulting from maintenance and/or repairs using parts other than repair parts specified by Kowa.
- 5) The input voltage should always be maintained within  $\pm 10\%$  of the rated voltage.
- 6) Do not turn on the flash lamp and adjust photography light intensity at the same time.
- 7) Wait for approx. 1 minute until the instrument has safely started up.
- 8) Do not turn the main power ON and OFF in succession. Allow an interval of at least 10 seconds before turning the main power ON and OFF.
- 9) Be sure to turn OFF the main power before connecting an external device.
- 10) Do not touch the patient and connectors at the same time as it may adversely affect the safety.
- 11) Disinfect using alcohol the parts accessible by the patient.
- 12) The power supply must be provided for the sole use of this instrument.

## 3. Precautions when using this instrument

- 1) Carefully handle the objective lens as soiled or scratched part of the objective lens may be imaged as white spots.
- 2) Always cover this instrument when not in use in order to protect them.
- 3) Do not apply strong shock or force to the objective lens.
- 4) Set a dial or knob with clicking positions to its designated position.
- 5) Do not press sharp instruments or tools against the LCD monitor or add excessive force to the monitor.
- 6) Never disassemble or adjust this instrument by yourself as it uses precision parts which requires special tool for doing so.

## 4. Disposal precautions

When disposing this instrument, applicable federal, state, and local regulations must be observed. Ensure that disposal is handled by a licensed industrial waste disposal contractor in accordance with the applicable regulations and ordinances.

## 5. Replacement of the Aluminum Electrolytic Capacitor

The aluminum electrolytic capacitor for the flash lamp, which is used in the power supply section of this instrument, is a component requiring regular replacements. The useful life of this type of components may be significantly reduced depending the frequency and conditions in which this instrument is used. If the capacitor is used beyond its useful life, its electrolytic solution may leak or drain, which can result in abnormal odor, smoke, bursting sound, and other failures.

The design life of the capacitor is 50,000 flashes when used in an ambient temperature of 25°C. This is, however, only a guideline, and the capacitor may need to be replaced earlier depending on the usage environment. In order to ensure safe and stable operation of this instrument, early replacement of the aluminum electrolytic capacitor is recommended. Replacement of components requiring regular replacement, such as aluminum electrolytic capacitor, is supported as a paid service. For more information about replacement of such components, please contact Kowa or your Kowa dealer.

## 6. Prescription device caution:



### Caution

Federal law restricts this device to sale by or on the order of a Physician or Practitioner.



• **Combination of medical electrical equipment and non-medical electrical equipment**

IEC 60601-1-1 “Safety requirements for medical electrical systems” describes the components combination grouped into various clinical settings. The brief overview of IEC 60601-1-1 is shown below.

Situation No.	Medically used room		Non-medically used room	Feasible solution (See clause 19 in all situations)	
	Inside the PATIENT ENVIRONMENT	Outside the PATIENT ENVIRONMENT			
1	1a Items A and B in PATIENT ENVIRONMENT	<div style="display: flex; justify-content: space-around; align-items: center;"> <div style="border: 1px solid black; padding: 2px; text-align: center;">A IEC 60601</div> <div style="border: 1px solid black; padding: 2px; text-align: center;">B IEC 60601</div> </div>			
	1b Items A and B in PATIENT ENVIRONMENT	<div style="display: flex; justify-content: space-around; align-items: center;"> <div style="border: 1px solid black; padding: 2px; text-align: center;">A IEC 60601</div> <div style="border: 1px solid black; padding: 2px; text-align: center;">B IEC XXXXX</div> </div>			For B:Additional protective earth or separating transformer
	1c Item A powerd from specified power supply in item B in PATIENT ENVIRONMENT	<div style="border: 1px solid black; padding: 2px; text-align: center;"> A IEC 60601  B IEC XXXXX </div>			For B:Additional protective earth or separating transformer
2	2a Item A in PATIENT ENVIRONMENT and item B in medically used room	<div style="display: flex; justify-content: space-around; align-items: center;"> <div style="border: 1px solid black; padding: 2px; text-align: center;">A IEC 60601</div> <div style="border: 1px solid black; padding: 2px; text-align: center;">B IEC 60601</div> </div>			
	2b Item A in PATIENT ENVIRONMENT and item B in medically used room	<div style="display: flex; justify-content: space-around; align-items: center;"> <div style="border: 1px solid black; padding: 2px; text-align: center;">A IEC 60601</div> <div style="border: 1px solid black; padding: 2px; text-align: center;">B IEC XXXXX</div> </div>			For B:See 19.201 and its rationale
3	3a Item A in PATIENT ENVIRONMENT and item B in non-medically used room	<div style="display: flex; justify-content: space-around; align-items: center;"> <div style="border: 1px solid black; padding: 2px; text-align: center;">A IEC 60601</div> <div style="border: 1px solid black; padding: 2px; text-align: center;">B IEC 60601 or IEC XXXXX</div> </div> <div style="border: 1px solid black; padding: 2px; text-align: center; margin-top: 5px;">Common protective earth</div>			For B:See 19.201 and its rationale
	3b Item A in PATIENT ENVIRONMENT and item B in non-medically used room	<div style="display: flex; justify-content: space-around; align-items: center;"> <div style="border: 1px solid black; padding: 2px; text-align: center;">A IEC 60601</div> <div style="border: 1px solid black; padding: 2px; text-align: center;">B IEC 60601 or IEC XXXXX</div> </div> <div style="border: 1px solid black; padding: 2px; text-align: center; margin-top: 5px;">Protective earth</div>			For B:Additional protective earth or SEPARATION DEVICE

**KEY TO TABLE**

- Additional protective earth : If necessary, provide additional protective earthing , which is permanently connected(See also 58.201).
- **NOTE** Equipment modification may be required.
- Separating transformer : If necessary, limit the ENCLOSURE LEAKAGE CURRENT, by using an additional separating transformer according to annex EEE.
- **NOTE1**No equipment modification is required.
- **NOTE2**A separating transformer is a transformer with one or more input winding(s) separated from the output winding(s) by at least basic insulation [IEC 60989].
- SEPARATION DEVICE : If necessary, apply SEPARATION DEVICE.
- IEC 60601 : MEDICAL ELECTRICAL EQUIPMENT in compliance with IEC 60601.
- IEC XXXXX : Non medical equipment in compliance with relevant IEC safety standards.

## 1. Precautions on use of medical electrical system

- 1) All components of this medical electrical system may be installed within a limited patient environment (a radius of 1.5 m around a patient) when all components are installed in accordance with the installation instructions using “Multi-tap with Isolation Transformer”, which is one of the system components.
- 2) As prerequisite for installing to this system, other components (a PC, printer, video capture printer, video monitor, or other devices) which do not comply with IEC60601-1 must be powered from Multi-tap with Isolation Transformer. The electric power to these components supplied from an electric source other than Multi-tap with Isolation Transformer (e.g., wall outlets) may cause increased enclosure leakage current or potential difference between protective grounds resulting in the injury to the patient or operator. Use Multi-tap with Isolation Transformer only for supplying the power to the components other than the system components.
- 3) Any medical electrical equipment that connected to this system to compose a medical system must comply with IEC60601-1.
- 4) Any non-medical electrical equipment that is connected to this system to compose a medical system must comply with safety standards of IEC or ISO provisions applicable to such a non-medical electrical equipment.
- 5) Do not use any additional multi-tap or extension power cable other than those Kowa specified to this system.
- 6) Power supply to this system or “Multi-tap with Isolation Transformer” must be provided individually. (Do not route the power supply through other multi-tap to the system or “Multi-tap with Isolation Transformer”.)
- 7) The power cable for an electrical equipment that compose a medical system must have durability that meets IEC60245/IEC60227 or higher standards.
- 8) Assure that the power supply is turned OFF when connecting other device to the system.
- 9) Do not turn ON the power supply until all devices are completely connected.
- 10) Do not place or install the devices and the system components on the unstable or inclined table.

## 2. Precautions for use of “Multi-tap with Isolation Transformer”

- 1) Do not place “Multi-tap with Isolation Transformer” directly on the floor. Water droplets during room cleaning may enter the multi-tap resulting in the component failure.
- 2) The power supply cable to “Multi-tap with Isolation Transformer” must be connected to a power receptacle with a protective ground terminal equipotential to the protective ground of this instrument.
- 3) When using a multi-tap power receptacle with a protective ground terminal, read the instruction for use attached to the receptacle to familiarize yourself with the correct use before use.

## 3. Daily maintenance and cleaning

- 1) System components
  - Wipe the soiled outer surface with firmly squeezed dampened soft cloth. Use mild detergent to remove excessive soils. Do not use chemicals or solvents such as thinner and benzene. (As the LCD monitor screen cover easily gets scratched, lightly wipe it with soft cloth such as gauze.)
  - Refer to the instruction for use provided with each device for details of device maintenance and cleaning.
- 2) Power cables, connecting cables, and connectors
  - Visually inspect that all cables have no flaw or damage.
  - Visually verify that earth leads of all components and protective ground terminals are securely connected.
  - Disconnect the power cables from the power supply receptacles when you do not use the system for a long period of time.
- 3) Others
  - When you add a PC to the system for a filing purpose, captured images are stored in the HDD of the PC. Back up the data stored in the HDD regularly since HDDs may have a mechanical or electrical failure.



# Operational considerations for hospital grade electrical instrument (safety and accident prevention)

- 1. Only qualified personnel should operate this instrument.**
- 2. The following items shall be considered when installing the instrument.**
  - 1) Install at a location away from water or accidental splashing.
  - 2) Install at a location which will not be adversely affected by atmospheric pressure, temperature, humidity, ventilation, sunlight, dust, air containing salt, sulfur and other substances, and the like.
  - 3) Take care to guard against tilt, vibration and strong impacts, for instance, during transportation.
  - 4) Instrument must not be installed at locations where chemicals are stored or gasses are generated.
  - 5) Be careful with the radio frequencies, voltages and allowable amperes (power consumption) of the power supply.
  - 6) Properly connect ground wires.
- 3. The following items shall be considered before using the instrument.**
  - 1) Make sure that instrument activates properly after checking switch contact, polarity, dial setting and meters and so forth.
  - 2) Make sure that the instrument is properly grounded.
  - 3) Make sure that all cords are properly connected and secured.
  - 4) Use of other instruments and appliances on the same power circuit is liable to cause errors and incorrect flash output resulting in incorrect diagnosis or hazards.
  - 5) External circuits and connectors that may come in direct contact with the patient must be checked frequently for signs of wear.
- 4. The following items shall be considered when using the instrument.**
  - 1) Be sure to minimize the time and quantity required for diagnosis and treatment.
  - 2) Always assure that the instrument and patient are in good condition.
  - 3) When an abnormality is found on the instrument, take proper measures, for instance, to stop the operation of the instrument while assuring the patient's safety.
  - 4) Do not allow the patient to touch any of the instrument controls.
- 5. The following items shall be considered after using the instrument.**
  - 1) Turn OFF the instrument after setting control switches, dials and so forth to their initial status following with a specified procedure.
  - 2) Do not pull cords for removal because an excessive force is exerted on them.
  - 3) The following shall be considered regarding storage location.
    - Store the instrument at locations free from splashes of water.
    - Store at a location which will not be adversely affected by atmospheric pressure, temperature, humidity, ventilation, sunlight, dust, air containing salt, sulfur and other substances, and the like.
    - Take care to guard against tilt, vibration and strong impacts, for instance, during transportation.
    - Instrument must not be stored at locations where chemicals are stored or gasses are generated.
  - 4) Clean and rearrange accessories, cords, and the like.
  - 5) The instrument must be cleaned prior to use so that there will be no problem when using it again.
- 6. In case of a problem or malfunction, stop the operation and contact Kowa or your Kowa dealer for repair.**
- 7. Instrument shall not be modified.**
- 8. Maintenance**
  - 1) Periodically check the instrument and its components for any abnormality.
  - 2) When using the instrument that has not been used for a while, it must be checked beforehand to assure that it is in normal condition and operates safely.
- 9. Be careful of the possibility that incorrect operation may be caused by strong electromagnetic waves.**



This instrument is examined based on IEC 60601-1-2.

The purpose of this standard is to keep safety against the dangerous obstacle in typical medical facilities. When this instrument is influenced by other instrument, or when it affects other instrument or when there is such fear, please devise to move this instrument and other apparatus or to make the distance between those instrument.







Moreover, if there is an unknown point, please consult our company, or an agency beforehand.

# Components and supplies

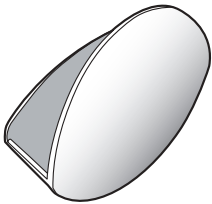
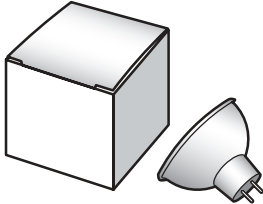

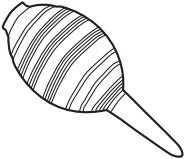
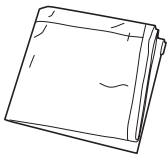
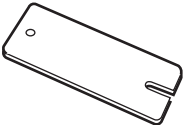

## Main unit

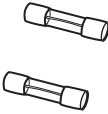
Optical Component	Power supply
	

## Accessories

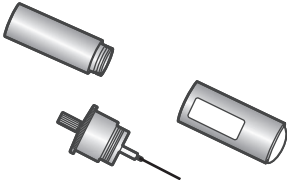
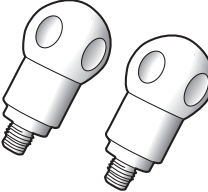
USB cable 1(A—mini-B type×2):1(2.3m)		Objective lens cap holder: 1		Illumination lamp: 1	
					
Instruction manual: 1 Setup manual: 1		Blower:1		Dust cover:1	
					
Chin rest paper:1	Chin rest paper retaining pins:2	Compact flash memory card: 1	Hex wrenches: 3	Head bands: 2	Fuses:2
					

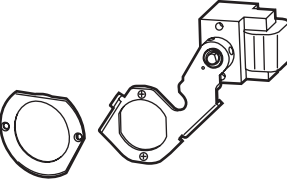
## Optional accessories

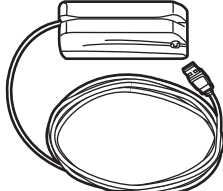
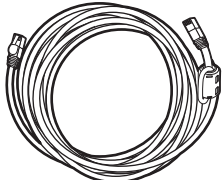
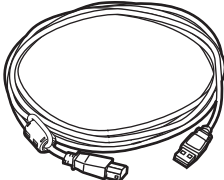
<p><b>Internal fixation target: 1</b> <b>K9L-PE56</b></p>	<p><b>Grips: 2</b> <b>K9L-GR56</b></p>	<p><b>Forehead rest: 1</b> <b>K9L-HR56</b></p>
		
<p><b>Exciter &amp; Barrier filter set for FAF: 1</b> <b>K9L-IF56K</b></p>	<p><b>Bar code reader: 1(1.6m)</b> <b>VK-CB2H</b></p>	<p><b>Card reader: 1(1.2m)</b> <b>VK-CB2G</b></p>
		
<p><b>LAN cable(cross):1(5m)</b> <b>K9L-SC56B</b></p>	<p><b>USB cable 2(A-B type):1(5m)</b> <b>K9L-SC56C</b></p>	
		



# MENU

<b>Introduction.....</b>	<b>I</b>
Operational considerations for safety .....	I
<b>Meanings of symbols .....</b>	<b>V</b>
<b>Operating precautions .....</b>	<b>VI</b>
<b>Precautions: use of medical electrical system.....</b>	<b>VIII</b>
<b>Operational considerations for hospital grade electrical instrument (safety and accident prevention) .....</b>	<b>IX</b>
<b>Components and supplies.....</b>	<b>X</b>
Main unit .....	X
Accessories .....	X
Optional accessories .....	XI
<b>MENU .....</b>	<b>XII</b>
<b>1 System description.....</b>	<b>1</b>
1.1 Indication for use .....	1
1.2 System overview.....	1
1.3 Features.....	1
1.4 Name and function of each component.....	2
1.5 LCD monitor indications .....	6
<b>2 Preparation .....</b>	<b>8</b>
2.1 Assembly and installation .....	8
2.2 Inserting/ removing compact flash memory card .....	8
2.3 System connection configuration.....	9
2.4 Turning ON the power .....	10
2.5 Turning OFF the power.....	10
2.6 Retinal camera preparation .....	11
2.7 Preparatory procedure of the examined eye .....	11
<b>3 Basic operation .....</b>	<b>12</b>
3.1 How to use the control lever .....	12
3.2 Non-mydratic photography/ autofluorescence photography procedures .....	13
3.3 Mydratic color/ Red Free photography procedures .....	16

3.4	Mydriatic Fluorescein angiography procedures .....	19
3.5	Viewer mode functions and procedures .....	23
<b>4</b>	<b>Advanced operation .....</b>	<b>30</b>
4.1	Tilt and panning .....	30
4.2	Small pupil photography .....	31
4.3	LCD Monitoring .....	33
4.4	Switching fixation target .....	34
4.5	Additional adjustment of the flash intensity(+5 or more, -5 or less) .....	37
4.6	Blue/Brown button .....	37
4.7	Customize button .....	37
4.8	Power saving function .....	38
4.9	Recalling and printing images .....	38
<b>5</b>	<b>Setting.....</b>	<b>39</b>
5.1	Main .....	39
5.2	Capture .....	41
5.3	Viewer .....	42
5.4	Advanced functions .....	43
5.5	Maintenance .....	46
<b>6</b>	<b>Troubleshooting.....</b>	<b>48</b>
<b>7</b>	<b>Maintenance and inspection.....</b>	<b>52</b>
7.1	Daily maintenance .....	52
7.2	Daily inspection .....	53
7.3	Daily cleaning .....	54
7.4	Replacement of consumables .....	55
7.5	Regular inspection .....	59
<b>8</b>	<b>Specifications .....</b>	<b>60</b>
<b>9</b>	<b>Technical information.....</b>	<b>61</b>
9.1	Folder structure and data format of the compact flash memory card .....	61
9.2	Number of photographs taken using the supplied memory card .....	63
9.3	File format and name of the files generated in the Network connection setting .....	63
<b>10</b>	<b>Light Hazard (ISO 15004-2) .....</b>	<b>64</b>
<b>11</b>	<b>Electromagnetic compatibility (IEC60601-1-2).....</b>	<b>68</b>





## 1.1 Indication for use

---

The KOWA VX-20 is intended for taking picture of retinal images with mydriatic or without mydriatic.

## 1.2 System overview

---

This instrument is a retinal camera, capable of capturing both non-mydriatic and mydriatic, has two photography field angles of 50° and 30° (45° and 27° for non-mydriatic), with ability to perform various photography such as Red Free photography and Fluorescence angiography and FAF photography (optionally available).

## 1.3 Features

---

- Provides filmless photography with full computerization
- Large screen touch the LCD monitor
- Significantly lowered eye level; as much as 75mm compared with the previous model
- Equipped with simplified filing function
- Finer flash compensation
- Gathering operations to close at hand
- Offers wide range of photography modes

# 1 System description

## 1.4 Name and function of each component

### Main unit

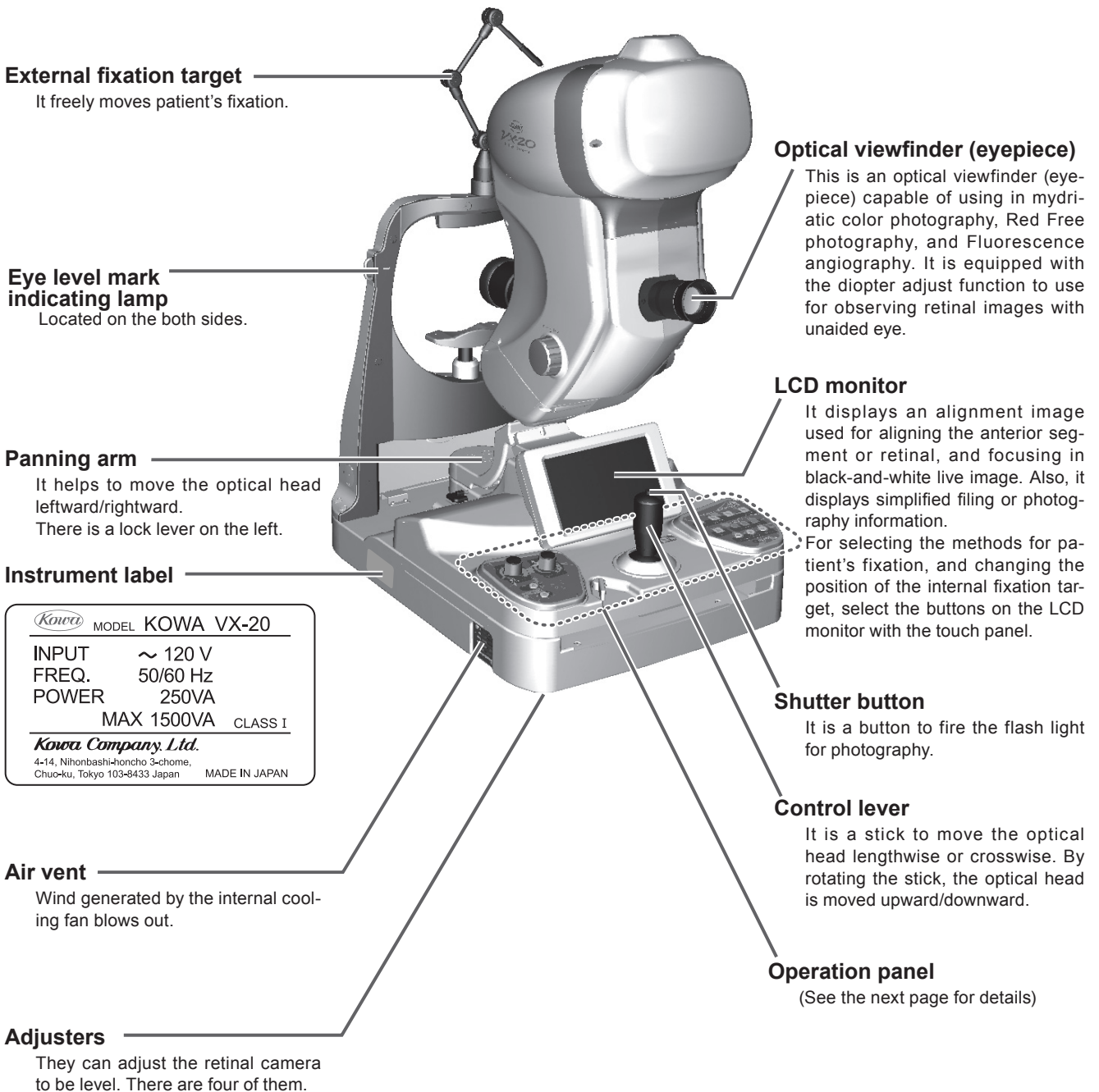

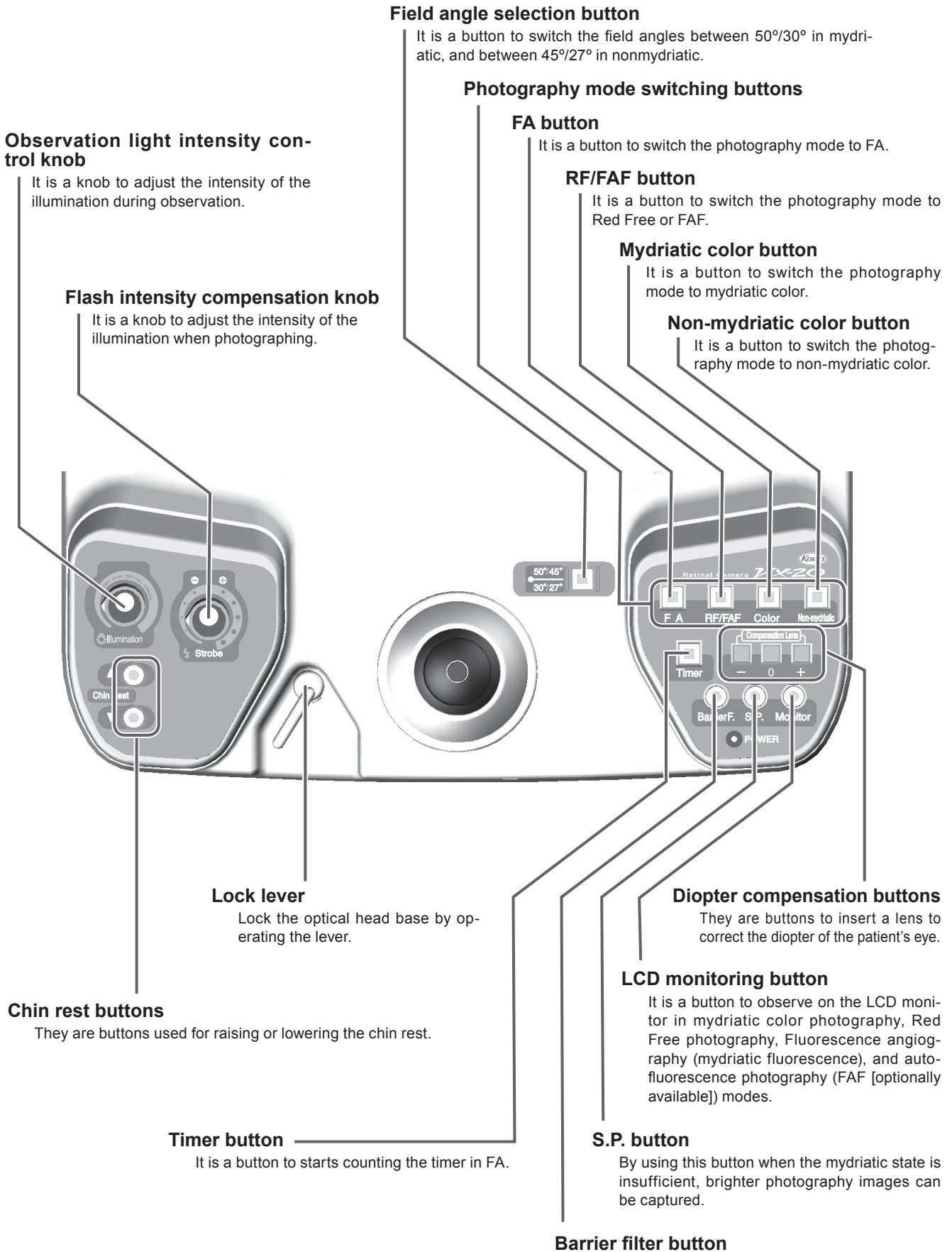

**Observation light intensity control knob**

It is a knob to adjust the intensity of the illumination during observation.

**Flash intensity compensation knob**

It is a knob to adjust the intensity of the illumination when photographing.

**Chin rest buttons**

They are buttons used for raising or lowering the chin rest.

**Timer button**

It is a button to starts counting the timer in FA.

**Lock lever**

Lock the optical head base by operating the lever.

**Field angle selection button**

It is a button to switch the field angles between 50°/30° in mydrionic, and between 45°/27° in nonmydrionic.

**Photography mode switching buttons**

**FA button**

It is a button to switch the photography mode to FA.

**RF/FAF button**

It is a button to switch the photography mode to Red Free or FAF.

**Mydrionic color button**

It is a button to switch the photography mode to mydrionic color.

**Non-mydrionic color button**

It is a button to switch the photography mode to non-mydrionic color.

**Diopter compensation buttons**

They are buttons to insert a lens to correct the diopter of the patient's eye.

**LCD monitoring button**

It is a button to observe on the LCD monitor in mydrionic color photography, Red Free photography, Fluorescence angiography (mydrionic fluorescence), and autofluorescence photography (FAF [optionally available]) modes.

**S.P. button**

By using this button when the mydrionic state is insufficient, brighter photography images can be captured.

**Barrier filter button**

# 1 System description

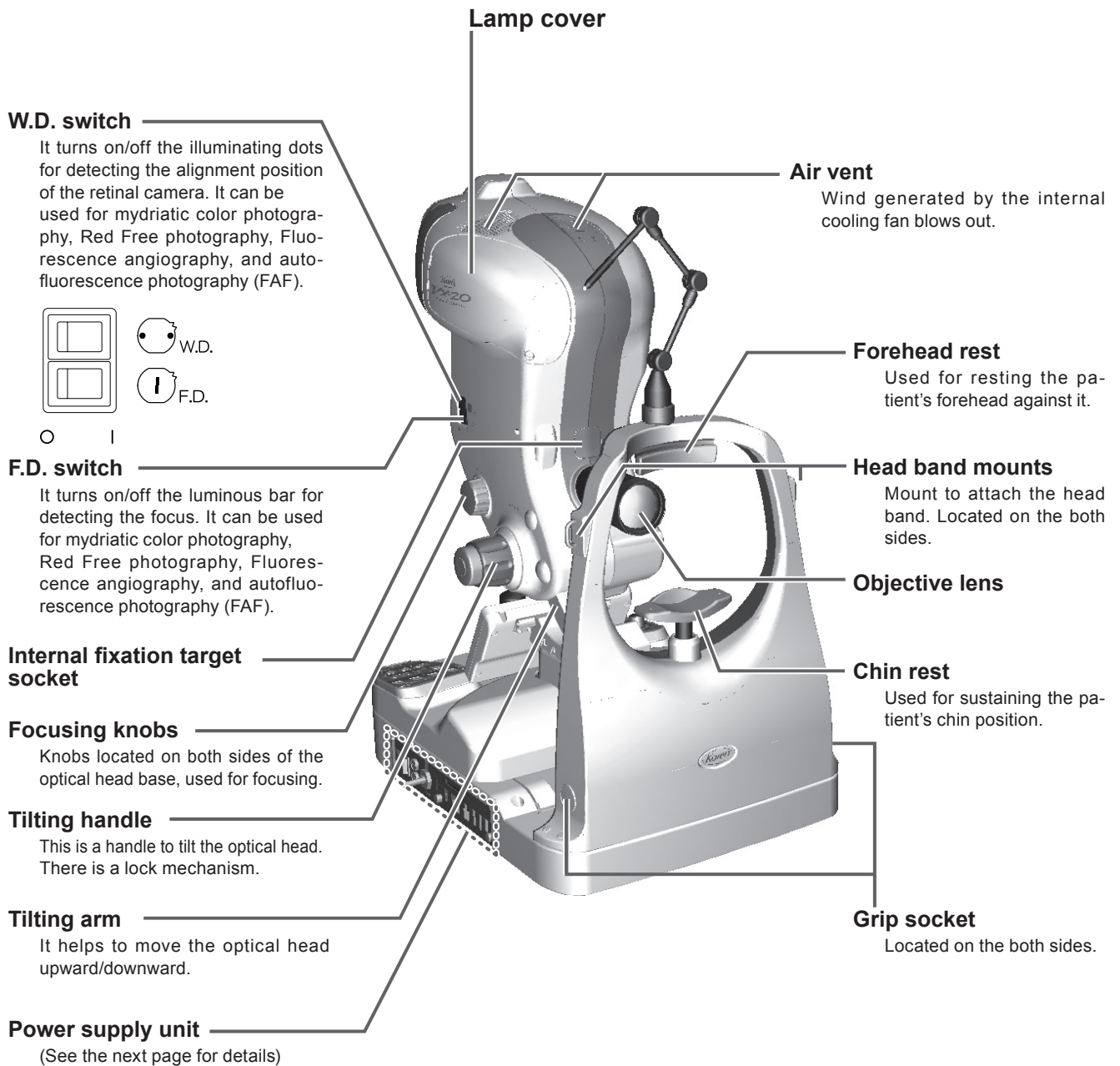

## I/O port

### Power supply unit

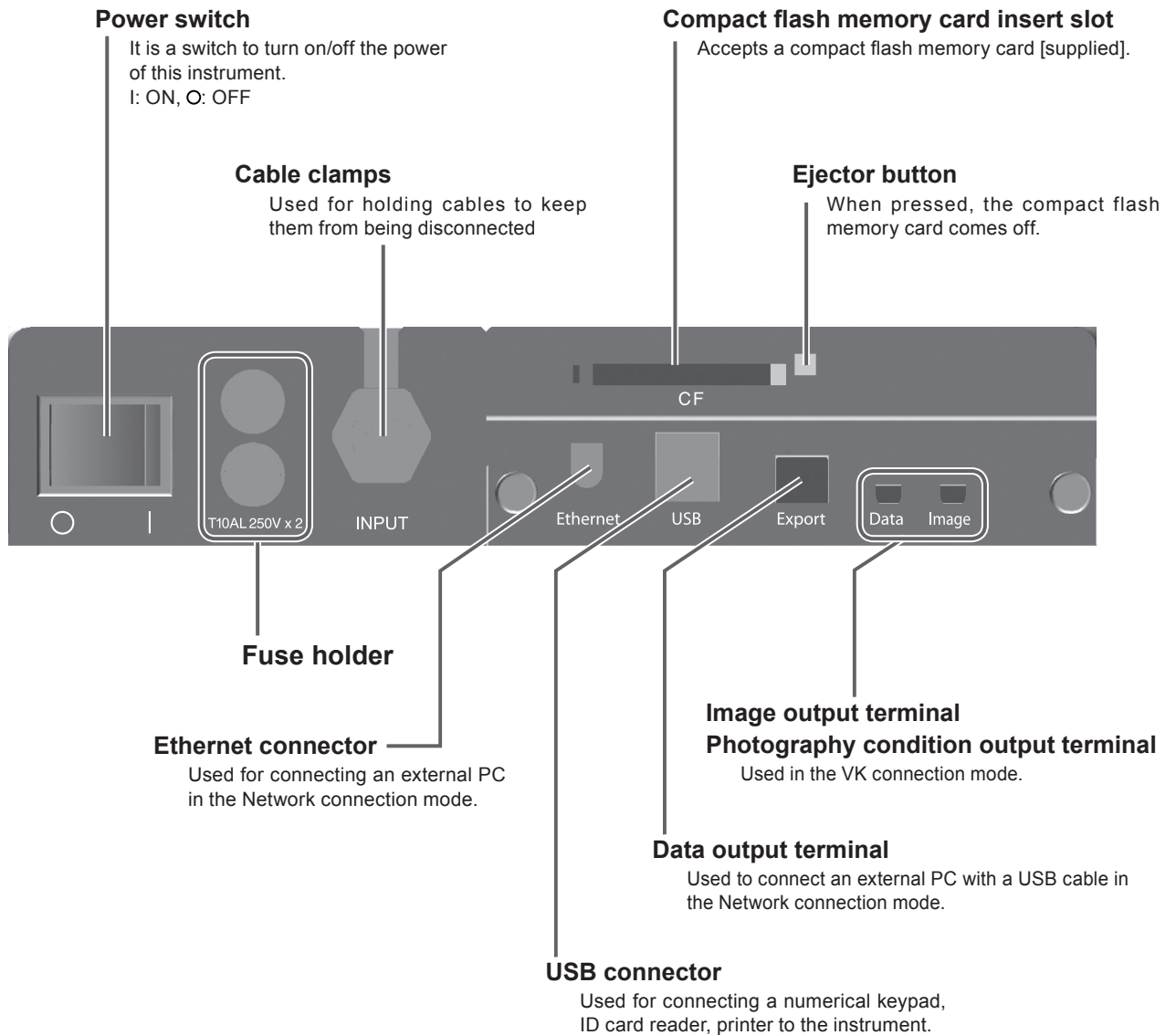

# 1 System description

## 1.5 LCD monitor indications

In this section, the information and buttons displayed on the LCD monitor are described.

### 1.5.1 Capture mode screen

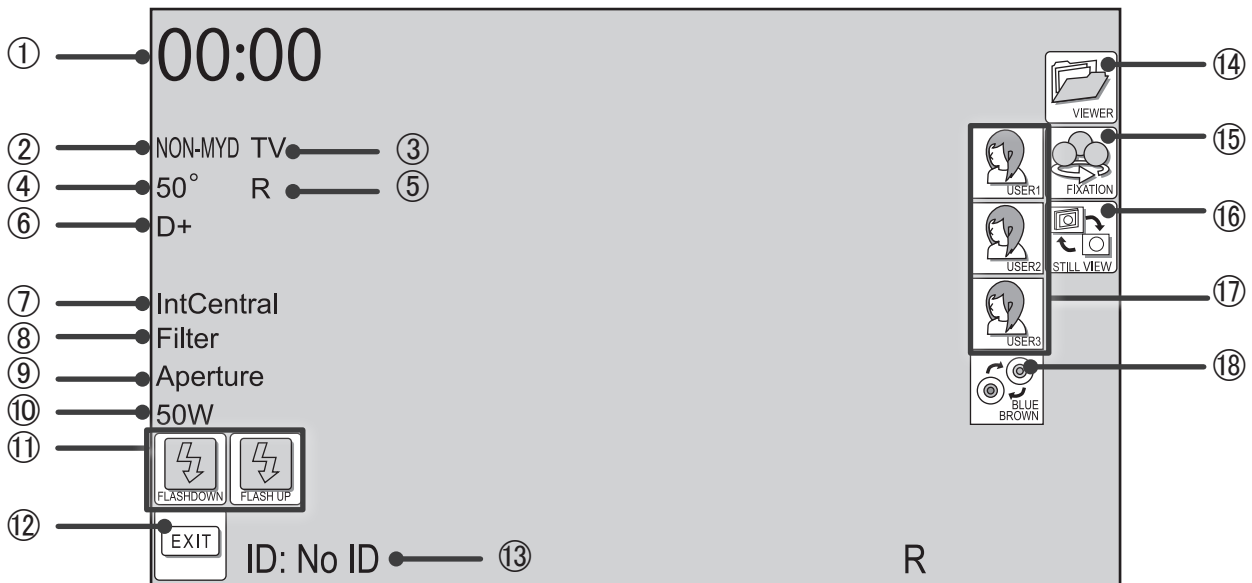

#### ① Timer

By pressing the timer button in the Fluorescence angiography mode, it will be displayed on the LCD monitor and start counting. It counts up to 59:59 in Minute:Second display.

#### ② Photography mode

This indicates the photography mode currently selected.

#### ③ LCD monitoring mode

Used for the LCD monitoring mode.

#### ④ Field angle

This indicates the current field angle.

#### ⑤ Left or right eye

This indicates which eye will be photographed.

#### ⑥ Diopter compensation

This indicates the state of the diopter compensation lens.

#### ⑦ Fixation target information

This indicates the information of the fixation target currently selected.

#### ⑧ Filter

It indicates whether the filter for fluorescent is inserted.

#### ⑨ Aperture

This indicates that a large value is selected in the aperture.

#### ⑩ Flash intensity

The intensity of light emitting from the photography flash lamp is indicated.

#### ⑪ Flash intensity compensation buttons

It appears when the flash intensity compensation knob on the panel is at the position of +5 or -5. It enables a wider range of light intensity compensation.

#### ⑫ EXIT button

It is a button to terminate this instrument. Press it to terminate the instrument before turning off the power switch.

#### ⑬ ID

The current patient's is indicated. Do not appear in VK connection mode.

#### ⑭ VIEWER button

It is a button to go to the Viewer mode from the Capture mode.

#### ⑮ Fixation target selection button

It is a button to select the fixation target. When this button is pressed, each fixation target is displayed in a button, and becomes selectable.

#### ⑯ STILL/VIEW selection button

It is a button to hide or display an image immediately after it is photographed. It is not displayed when VK connection is selected.

#### ⑰ Customize button

It is a user-defined button in the setting.

#### ⑱ Blue/Brown button

Used to adjust the intensity which is suitable for blue eyes.

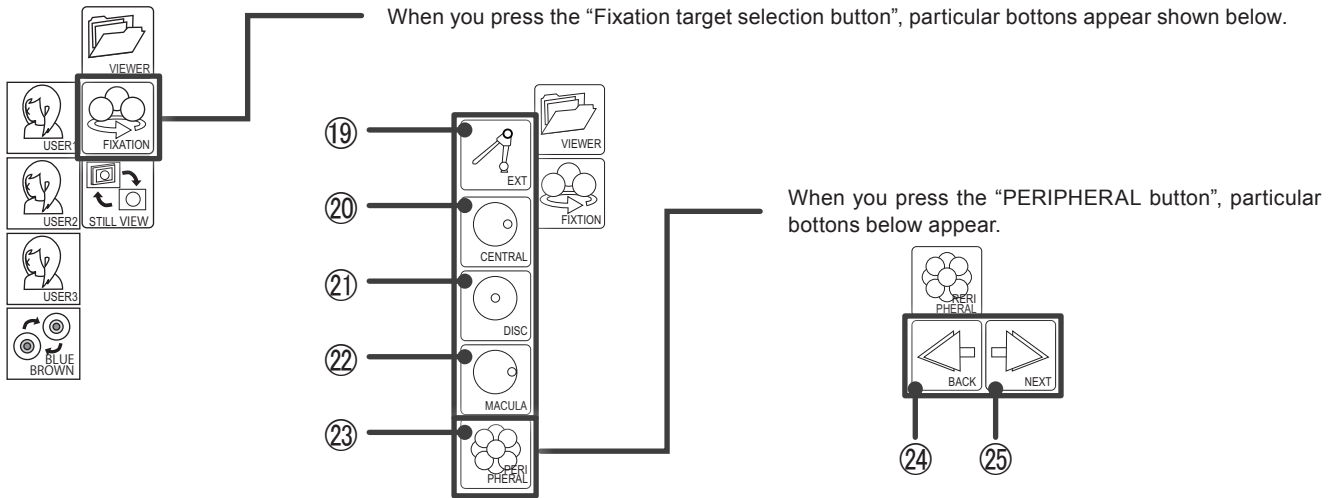

⑱ EXT button

⑳ CENTRAL button

㉑ DISC button

㉒ MACULA button

㉓ PERIPHERAL button

㉔ BACK button

㉕ NEXT button

### 1.5.2 Viewer mode screen

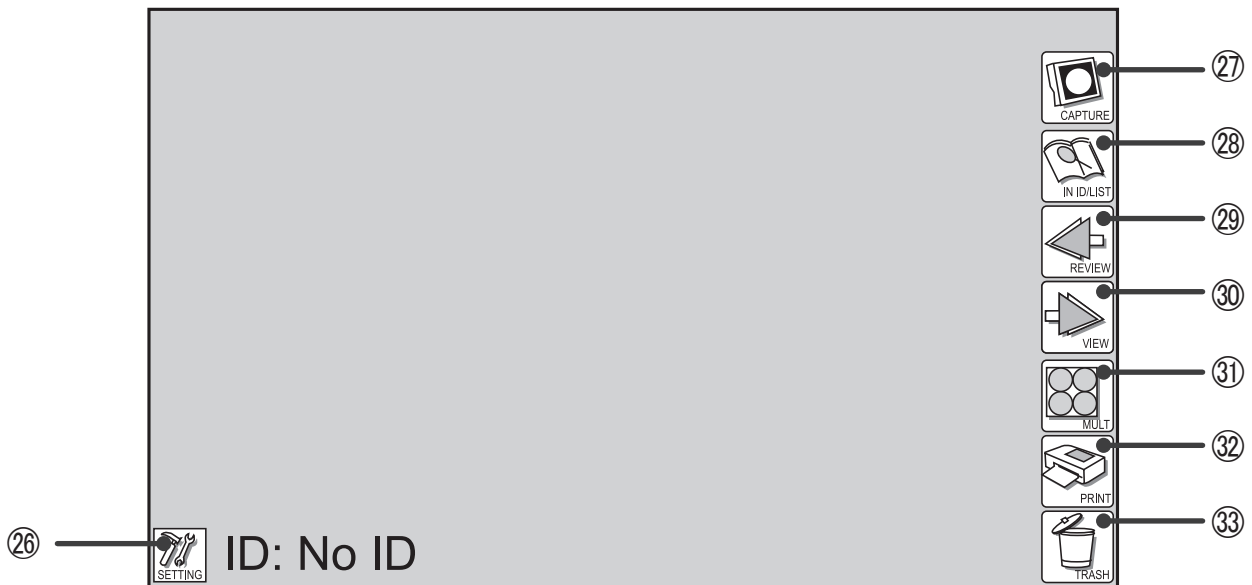

⑳ Setting button

It is a button to set various settings.

㉗ CAPTURE button

Used for changing to the Capture mode.

㉘ Input ID button

It is a button to input IDs.

㉙ REVIEW button

Used to display a previous image of the currently played image.

㉚ VIEW button

Used to display a next image of the currently played image.

㉛ MULT button

Used to display an image of the same ID in four sections.

㉜ PRINT button

Used to print out the currently displayed image.

㉝ TRASH button

Used to delete the currently displayed image from the compact flash memory card.

## 2.1 Assembly and installation

- ① Following the assembly manual provided separately, assemble the power supply unit and the optical component. Assembly must be done by qualified personnel who have received assembly training provided by Kowa or a Kowa dealer.
- ② Place the retinal camera on a stable surface, such as a powered optical table (optional device).
- ③ As needed, adjust the adjuster so that the retinal camera will be level.

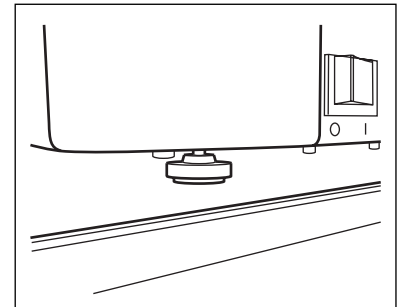

- ④ Make sure that the power switch is in the OFF position, and connect the power supply cable plug to a 120VAC power outlet.
- ⑤ If you want to attach the objective lens cap holder, attach it directly on or near the instrument.

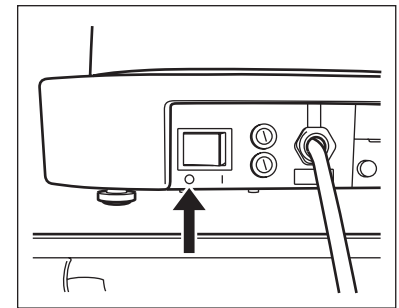
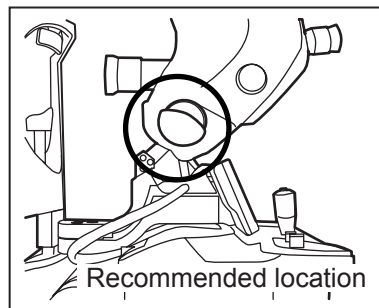

## 2.2 Inserting/ removing compact flash memory card

When using the instrument in the Stand-alone setting (see “2.3.1 Stand-alone”), make sure that the compact flash memory card is inserted. To transfer data from compact flash memory card to a computer, follow the procedures and notice below to remove the card.

### 2.2.1 Inserting a compact flash memory card

Slowly insert the supplied compact flash memory card, Kowa logo facing up, in the compact flash memory card insert slot as far as it goes.

Check that the ejector button comes out.

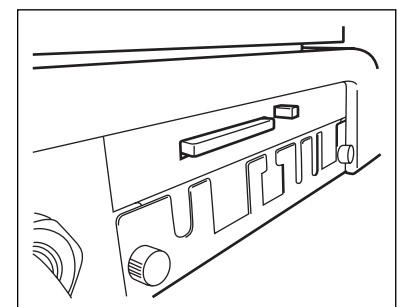

#### ⚠ Notice ●●●●●

- \* Do not use a compact flash memory card other than the one supplied with the instrument.
- \* Do not use any compact flash memory card other than the one supplied with this instrument or designated by Kowa.



### 2.2.2 Removing a compact flash memory card

Slowly press the ejector button to eject the compact flash memory card.

Then, hold and slowly pull out the card.

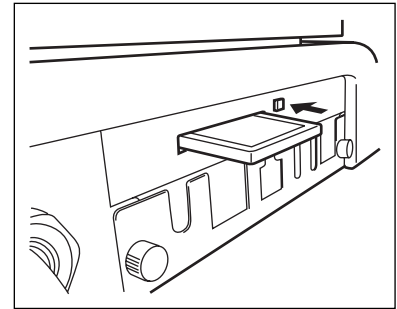

#### ⚠ Notice ●●●●●

- \* Do not attempt to remove the compact flash memory card without using the ejector button.
- \* Do not remove the compact flash memory card immediately after an image is photographed.

## 2.3 System connection configuration

This instrument may be used in 3 connection configurations.

- Stand-alone: Images taken by the instrument are acquired by the instrument itself as a stand-alone system.
- VK connection: Images taken by the instrument are acquired directly by Kowa filing system.
- Network connection: Images taken by the instrument are acquired by a computer via a network.



### Important

- When you use a peripheral device and/or other device connected to the peripheral device, it must meet all applicable EN(IEC) standards.
- Data processing device must meet IEC60601-1 or IEC60950.  
The system that combines such data processing device must meet IEC60601-1-1. The system administrator who builds such system bears all responsibility to have the system comply with requirement of IEC60601-1-1. Should you have any question, contact Kowa or your Kowa dealership.

### 2.3.1 Stand-alone (factory default)

Following the procedure described in Section 2.2.1, insert the compact flash memory card.

As needed, connect a USB-enabled printer to "USB connector" port.

- \* The maximum power that may be supplied through a USB port is 500 mA.

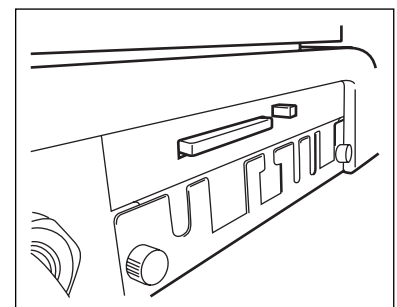

#### ⚠ Notice ●●●●●

- \* In the Stand-alone setting, photographed images are saved in the compact flash memory card inserted to this instrument. Photography function is disabled when the compact flash memory card becomes full. Damage to the compact flash memory card may result in an inability to access to the data saved in the card. Transfer data in the card to a computer on a regular basis.

## 2 Preparation

### 2.3.2 VK connection

In order to use this instrument in the VK connection setting, Kowa VK series (optional device) and the USB cable 1 are required.

For information on the installation and use of the VK series, refer to the installation and the user manuals supplied with the VK series.

Use the USB cable 1 to connect “Image output terminal” and “photography condition output terminal” of this instrument and USB ports of the VK series. Use a designated USB port to connect if you are instructed to do so.

After starting up this instrument, change the connection configuration to “VK connection” following the procedure described in Section 5.1.5. After the instrument is started up, a message “No compact flash memory card” appears as you switch to the viewer mode; press “OK” and continue.

When the instrument is connected to the VK series and the correct settings are made on both the instrument and the VK series, be sure to photograph images as a trial and check that images and photographing conditions are correctly acquired.

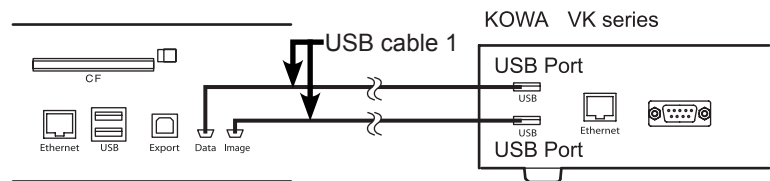

### 2.3.3 Network connection

In order to use this instrument in the Network connection setting, a computer (optional device) with image acquisition software installed is required along with K9L-SC56B (optional accessory) or K9L-SC56C (optional accessory).

To use the instrument in this setting, you must establish a network containing this instrument and other external devices. The network must be established by Kowa or a Kowa dealer representative and qualified personnel knowledgeable in network configuration; therefore, please contact Kowa or a Kowa dealer in advance.

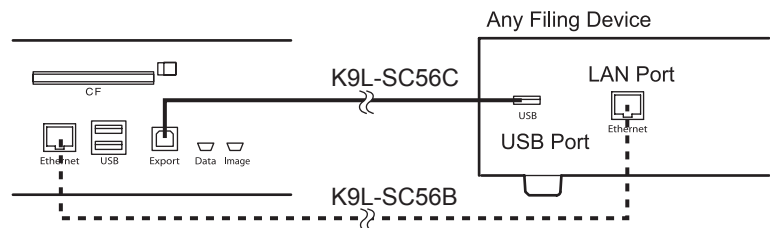

## 2.4 Turning ON the power

- ① Turn ON power switch.
- ② It takes approximately 40 seconds for the instrument to be fully ready for operation. Wait until the start-up logo disappears and photography information is displayed on the LCD monitor.

## 2.5 Turning OFF the power

- ① Make sure that the instrument is in the capture mode. If it is in the viewer mode, press “CAPTURE button” to go to the capture mode.
- ② Press “EXIT button”. A message appears asking whether you want to end the operation; if there is no problem, press “OK” to turn off the optical head.
- ③ The LCD monitor goes dark and all panel lamps except for the Power lamp go off. When the Power lamp turns orange, switch the power switch to the OFF position.

### ⚠ Notice ●●●●●

- \* Turning OFF the instrument without following the above procedures may result in a loss of data or damage to the instrument. With an exception of emergency situations, follow the above procedures to turn OFF the instrument.
- \* The power switch does not go OFF automatically. Do not forget to turn OFF the power switch.

## 2.6 Retinal camera preparation

Following the daily inspection list in “7.2 Daily inspection”, prepare the retinal camera for operation.

## 2.7 Preparatory procedure of the examined eye

- ① In case of mydriatic photography, apply mydriatic eye drops to the examined eye. After it dilates fully, guide the patient to the retinal camera. In case of non-mydriatic photography, take the patient to a dark room and let the examined eye dilate spontaneously.
- ② Make sure that the pupil is sufficiently open.  
Sufficient diameter of the pupil is 5.5 mm or more in mydriatic mode, 4.0 mm or more in small pupil mode and 4.0 mm or more in non-mydriatic mode.

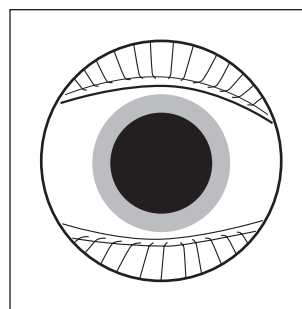

Mydriatic photography is enabled if 5.5 mm or more in diameter.

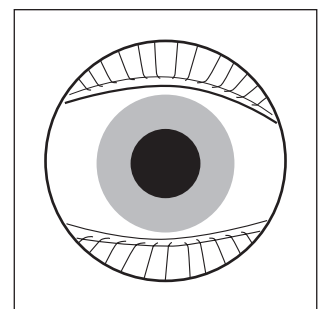

Small pupil or non-mydriatic photography is enabled if 4.0 mm in diameter.

### 3) Fixing the patient

1. Instruct the patient whose eyes are dilated sufficiently, to be seated in front of the retinal camera.
2. Adjust the height of a powered optical table to let the chin on the chin rest and the forehead on the forehead rest in a natural posture.
3. The height of chin rest can be adjusted with the chin rest buttons.
4. Set the examined eye at the eye level mark indicating lamp. (See illustration on the right.)

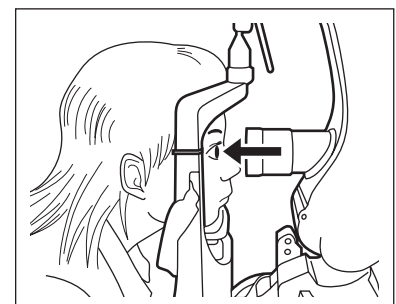

### Important

- When using mydriatic eye drops, be sure to follow the instruction of the eye drops.

### 3.1 How to use the control lever

The control lever is used to move the optical component of the retinal camera lengthwise or crosswise, and upward/downward. When roughly divided, there are three ways to use it:

- Coarse motion: moves the optical component lengthwise or crosswise broadly.
- Fine motion: moves the optical component lengthwise or crosswise finely.
- Upward/downward motion: moves the optical component upward/downward.

#### For coarse motion control

- ① Grab the control lever completely in a hand.
- ② While holding the control lever in upright position, move it lengthwise or crosswise so that the entire panel will move.

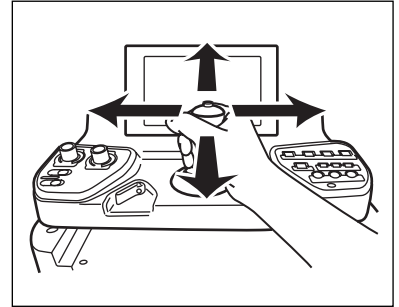

#### For fine motion control

- ① Hold the control lever with your finger tips.
- ② Tilt the control lever lengthwise or crosswise.  
The optical component is moved to the direction where the control lever is tilted.

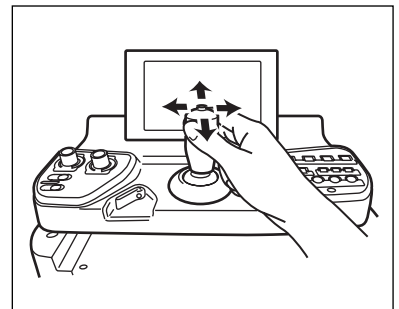

#### For upward/downward motion control

- ① Hold the control lever with your finger tips.
- ② Rotate the control lever, the optical component is moved upward/downward.  
Rotate clockwise: the optical component is moved upward.  
Rotate counterclockwise: the optical component is moved downward.

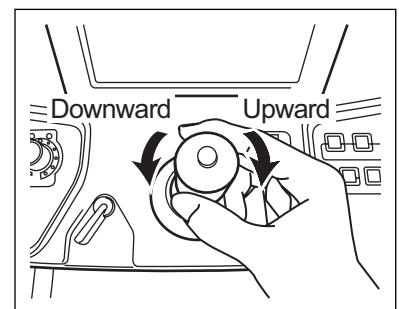

## 3.2 Non-mydriatic photography/ autofluorescence photography procedures

This section describes the basic operation procedures for non-mydriatic and autofluorescence photography. The operation of buttons explained in the procedures is based on the factory default. If the settings have been changed, operate the buttons according to the modified settings. In order to photograph images with natural dilation, dim the illumination of the room so that you may barely manage to read a newspaper (approx. 5 lx.)

① Enter, switch, or check the ID.

According to the system connection configuration, enter, switch, or check the patient's ID.

In the Stand-alone setting, the patient's ID may be entered or switched. Refer to 3.5.1 to enter an ID or switch between IDs.

In the VK connection setting, IDs are managed through the VK series connected to this instrument. Please read the user manual supplied with the VK series for operational procedures.

In the Network connection setting, the function depends on the external device connected to the instrument. Follow the user manual of the external device for the details on available functions and operational procedures.

② Select a photography mode.

With the "photography mode switching buttons" on the right side panel, press the "Non-mydriatic button" once for non-mydriatic photography; press the "RF/FAF button" twice for autofluorescence photography.

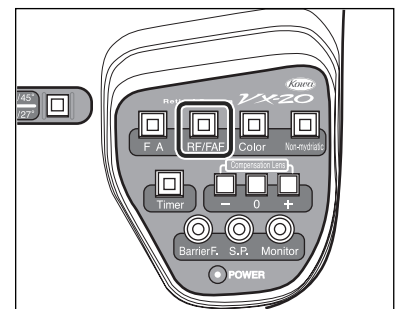
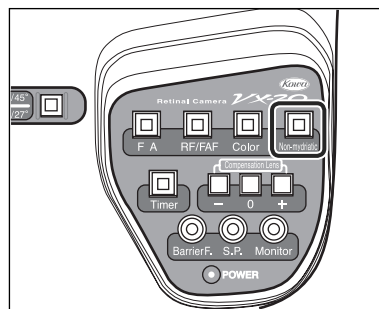

③ Adjust the flash intensity.

The flash intensity is automatically set according to the photography mode. If it is necessary to adjust flash intensity, you may do so with the flash intensity compensation knob.

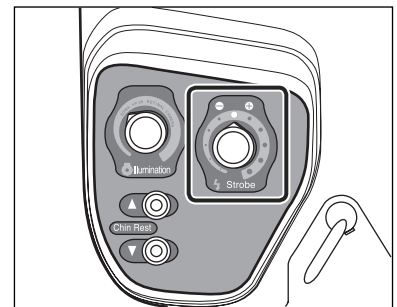

④ Select a field angle.

Press the "field angle selection button" to select a field angle.

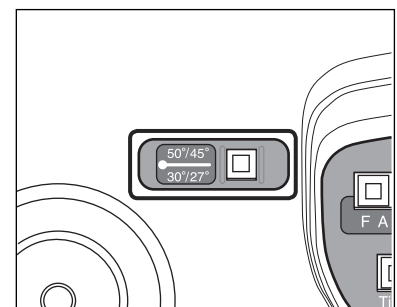

### 3 Basic usage

⑤ Select a fixation target.

Press the “fixation target selection button” on the LCD monitor to select a fixation target and the position of the patient’s eye fixation.

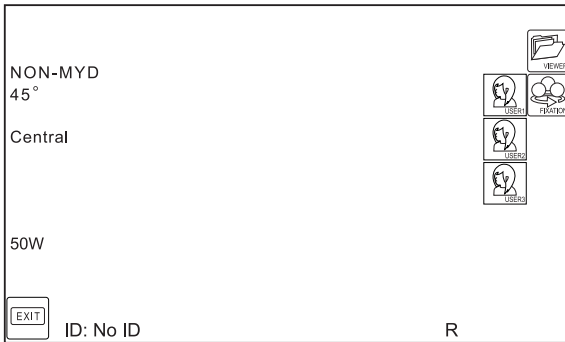

⑥ Compensate the diopter.

As needed, press the “diopter compensation buttons” on the right side panel and use the diopter compensation lens. The diopter range of each button is shown below.

- +: +10 to +35D
- 0: -12 to +13D
- : -32 to -10D

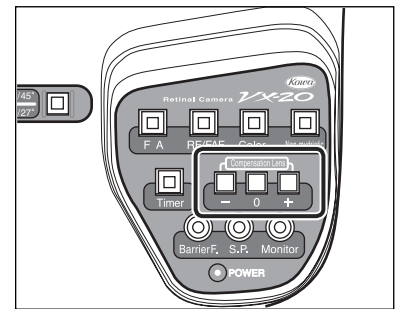

⑦ Pull the main unit towards you as far as it goes, and move the optical head base horizontally and/or the optical component vertically so that the patient’s eye is displayed in the center of the LCD monitor.

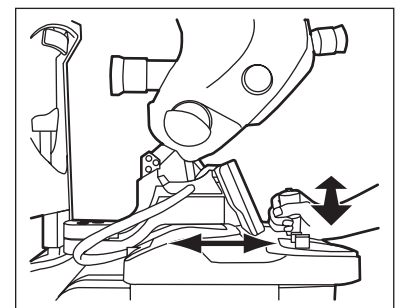

⑧ Adjust the working length.

Slowly move the optical head base forward until the working dot is shown on the retinal image. (Coarse motion)

Adjust the position of the main unit so that the working dot shown on the retinal image becomes the brightest on the working dot aid. (Fine motion)

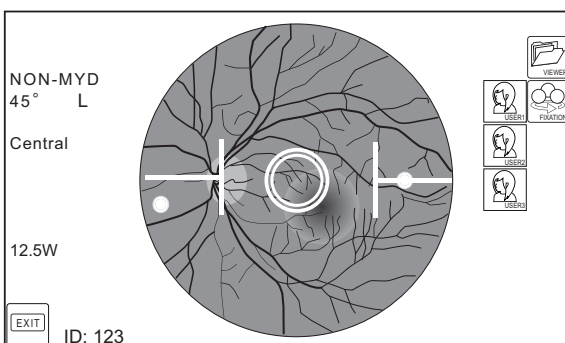

NG

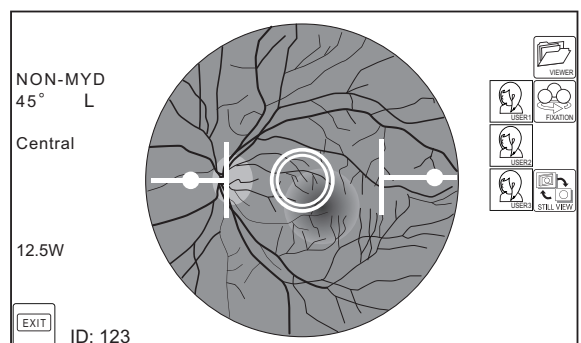

OK

⚠ Notice

\* Maintain a sufficient distance to avoid hitting the patient while moving the instrument in a coarse motion.

## ⑨ Adjust the focus.

Turn the “focusing knob” to adjust the focus. When you turn the focusing knob, the focus dots on the LCD monitor move left and right. Turn the focusing knob so that the upper and lower focus dots come to form a straight line.

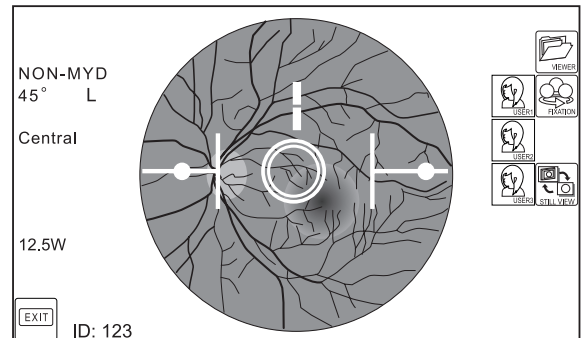
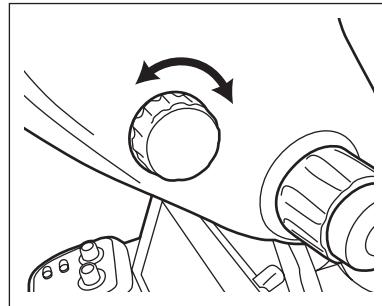

OK

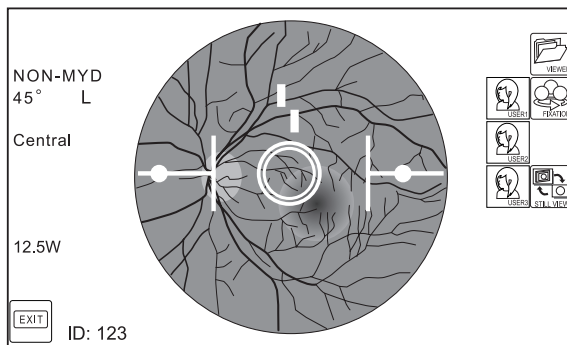

NG

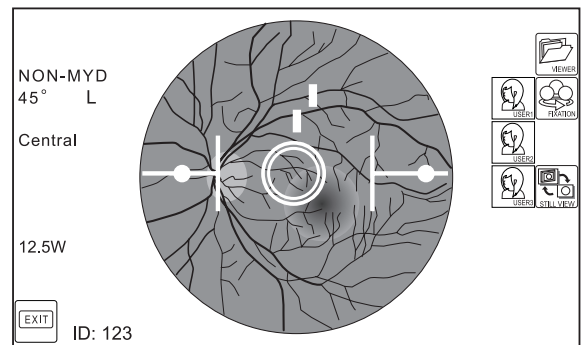

NG

## ⚠ Notice ●●●●●

\* The focus dots are not displayed when using the diopter compensation lens. Adjust the focus as you view the retinal image on the LCD monitor.

## ⑩ Photograph the image.

Press the “shutter button” to activate the flash and photograph the image.

When the connection configuration in “Stand-alone” or “Network connection”, images are displayed in the preview window immediately after they are photographed

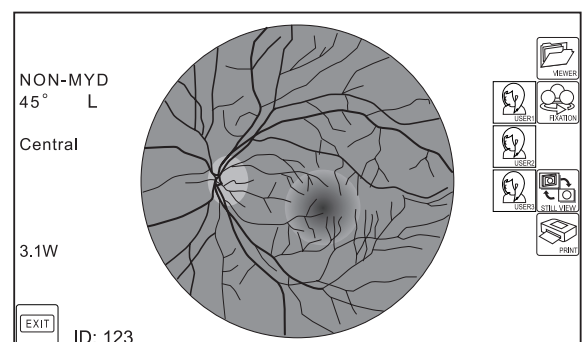
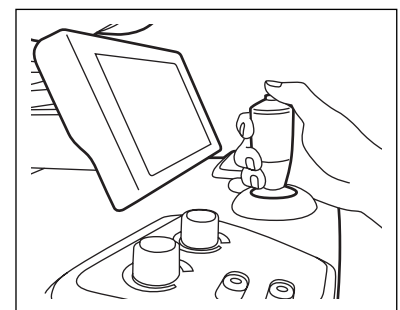

### 3.3 Mydriatic color/ Red Free photography procedures

This section describes the basic operation procedures for mydriatic color photography and Red Free photography.

#### ⚠ Notice

- \* In some cases, the use of mydriatics may aggravate patient's medical conditions or cause some patients to go into shock. Be sure to read the instruction for use carefully before using mydriatics, and follow the instruction.
- \* After photography using mydriatics, patient's pupils are dilated; therefore, patients may experience glaring or blurred vision. Instruct patient to be careful when they walk or move around and refrain from driving.

#### ① Enter, switch, or check the ID.

According to the system connection configuration, enter, switch, or check the patient's ID.

In the Stand-alone setting, the patient's ID may be entered or switched. Refer to 3.5.1 to enter an ID or switch between IDs.

In the VK connection setting, IDs are managed through the VK series connected to this instrument.

Please read the user manual supplied with the VK series for operational procedures.

In the Network connection setting, the function depends on the external device connected to the instrument. Follow the user manual of the external device for the details on available functions and operational procedures.

#### ② Select a photography mode.

With the "photography mode switching buttons" on the right side panel, press the "Mydriatic color button" for mydriatic photography; press the "RF/FAF button" for Red Free photography.

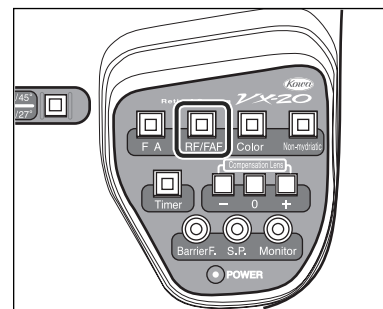
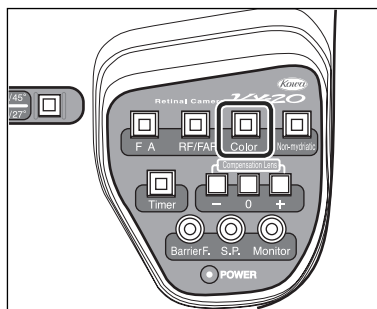

#### ③ Compensate the diopter of the optical viewfinder. (eyepiece)

Clear of all objects within the distance of 3m from the objective lens.

Look through the optical viewfinder (eyepiece) and rotate the diopter adjuster ring until the double lines become clear.

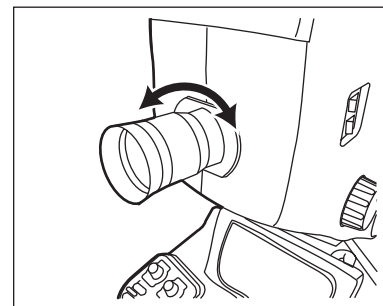



- ④ Adjust the flash intensity.  
The flash intensity is automatically set according to the photography mode. If it is necessary to adjust flash intensity, you may do so with the flash intensity compensation knob.

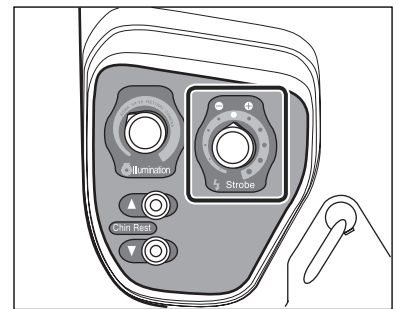

- ⑤ Select a field angle.  
Press the “field angle selection button” to select a field angle.

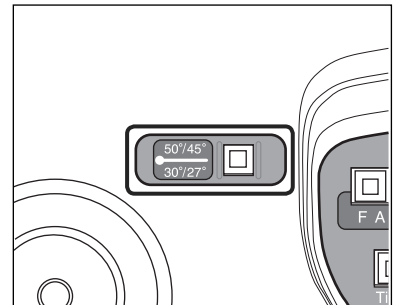

- ⑥ Compensate the diopter.  
As needed, press the “diopter compensation buttons” on the right side panel and use the diopter compensation lens.  
The diopter range of each button is shown below.

+: +10 to +35D  
0: -12 to +13D  
-: -32 to -10D

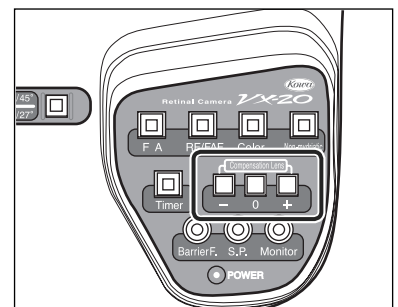

- ⑦ Pull the main unit towards you as far as it goes, and move the optical head base horizontally and/or the optical component vertically so that the patient's eye is displayed in the center of the LCD monitor.

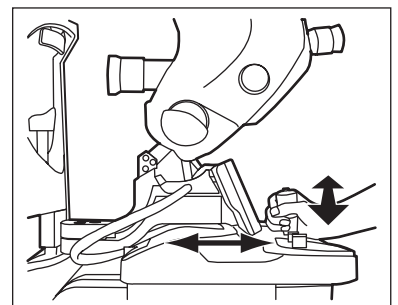

- ⑧ Adjust the working length.  
Move the optical head base forward until the patient's pupil and the ring illumination coincide. (Coarse motion)  
Adjust the position of the main unit so that the working dot shown on the retinal image becomes the brightest over the working dot aid. (Fine motion)

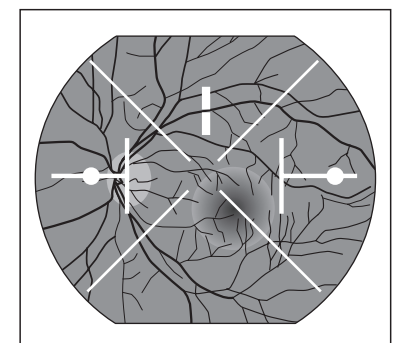

#### ⚠ Notice ●●●●●

- \* Maintain a sufficient distance to avoid hitting the patient while moving the instrument in a coarse motion.

### 3 Basic usage

⑨ Guide the patient's fixation.

Use the external fixation target to guide the patient's fixation position until the part you want to photograph becomes visible through the optical viewfinder (eyepiece).

- \* Position the external fixation target where the patient can fix the vision with the eye not examined.
- \* If the patient's fixation cannot be achieved with the eye not photographed, press the "LCD monitoring button"; then, select an internal fixation target using the "fixation target selection button", or use the internal fixation target (optional accessory) to guide the patient's fixation.

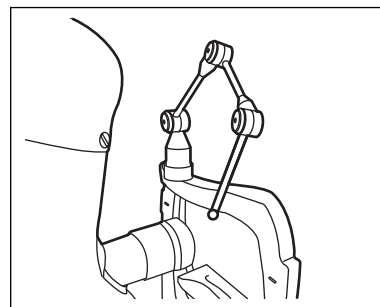

⑩ Adjust the focus.

Turn the "focusing knob" to adjust the focus. When you turn the focusing knob, the focus dots on the LCD monitor move left and right. Turn focusing knob so that the upper and lower focus dots come to form a straight line.

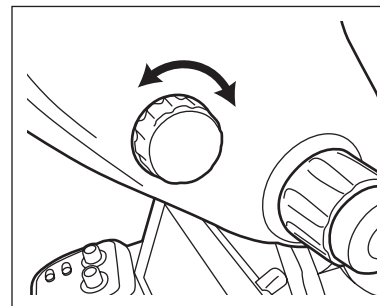

⚠ Notice ●●●●●

- \* The focus dots are not displayed when using the diopter compensation lens. Adjust the focus as you view the retinal image on the LCD monitor.

⑪ Photograph the image.

Press the "shutter button" to activate the flash and photograph the image.

When the connection configuration is in "Stand-alone" or the "Network connection", images are displayed in the preview window.

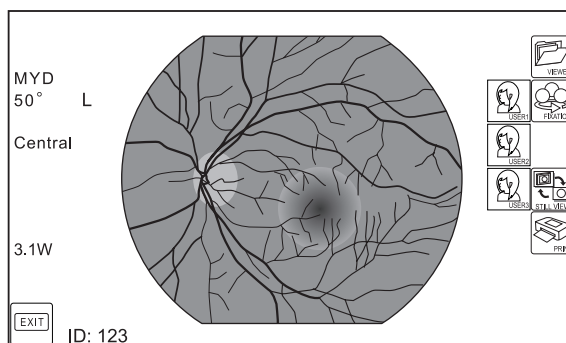
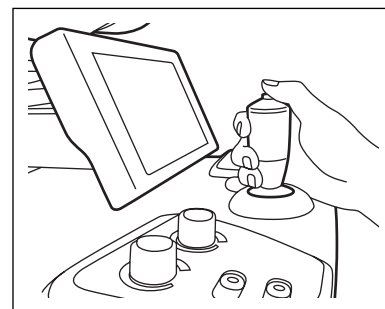

## 3.4 Mydriatic Fluorescein angiography procedures

This section describes the basic operation procedures for mydriatic Fluorescein angiography.

### ⚠ Notice ●●●●●

- \* In some cases, the use of mydriatics may aggravate patient's medical conditions or cause some patients to go into shock. Be sure to read the instruction for use carefully before using mydriatics, and follow the instruction.
- \* After photography using mydriatics, patient's pupils are dilated; therefore, patients may experience glaring or blurred vision. Instruct patient to be careful when they walk or move around and refrain from driving.
- \* In some cases, the use of fluorescent agent may aggravate patient's medical conditions or cause some patients to go into shock. Monitor the patient closely during photography and make sure that there are no abnormal changes in the patient. Be sure to read the instruction for use carefully before using fluorescent agent, and follow the instruction.

#### ① Enter, switch, or check the ID.

According to the system connection configuration, enter, switch, or check the patient's ID.

In the Stand-alone setting, the patient's ID may be entered or switched. Refer to 3.5.1 to enter an ID or switch between IDs.

In the VK connection setting, IDs are managed through the VK series connected to this instrument. Please read the user manual supplied with the VK series for operational procedures.

In the Network connection setting, the function depends on the external device connected to the instrument. Follow the user manual of the external device for the details on available functions and operational procedures.

#### ② Select a photography mode.

With the "photography mode switching buttons" on the right side panel, press the "FA button".

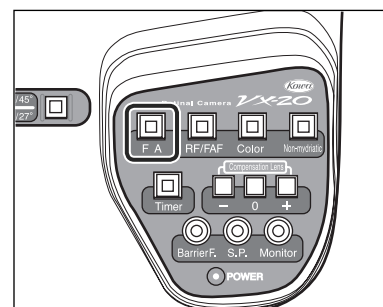

#### ③ Compensate the diopter of the optical viewfinder (eyepiece)

Clear of all objects within the distance of 3m from the objective lens.

Look through the optical viewfinder (eyepiece) and rotate the diopter adjuster ring until the double lines becomes clear.

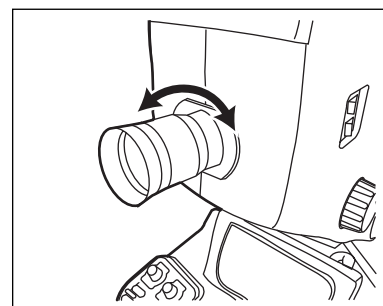

### 3 Basic usage

④ Adjust the flash intensity.

The flash intensity is automatically set according to the photography mode. If it is necessary to adjust flash intensity, you may do so with the flash intensity compensation knob.

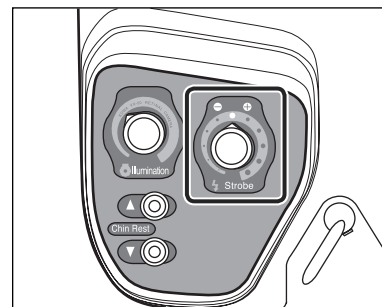

⑤ Select a field angle.

Press the "field angle selection button" to select a field angle.

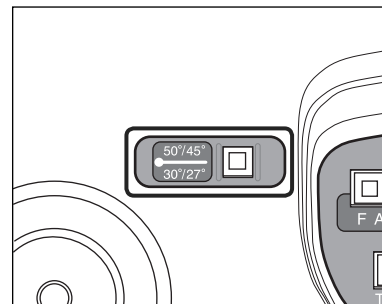

⑥ Compensate diopter.

As needed, press the "diopter compensation buttons" on the right side panel and use the diopter compensation lens. The diopter range of each button is shown below.

- +: +10 to +35D
- 0: -12 to +13D
- : -32 to -10D

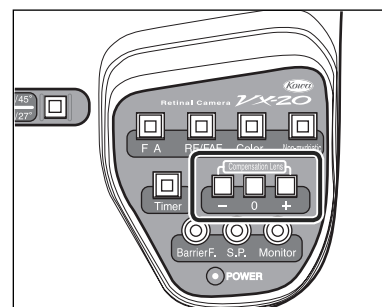

⑦ Pull the main unit towards you as far as it goes, and move the optical head base horizontally and/or the optical component vertically so that the patient's eye is displayed in the center of the LCD monitor.

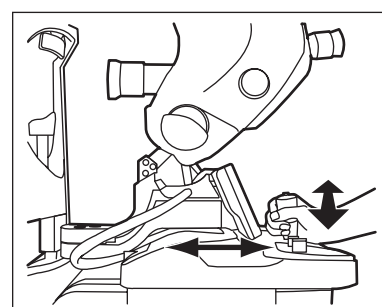

⑧ Adjust the working length.

Move the optical head base forward until the patient's pupil and the ring illumination coincide. (Coarse motion)  
Adjust the position of the main unit so that the working dot shown on the retinal image becomes the brightest over the working dot aid. (Fine motion)

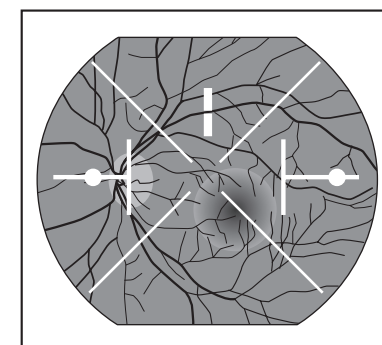

⚠ Notice ●●●●●

\* Maintain a sufficient distance to avoid hitting the patient while moving the instrument in a coarse motion.

## ⑨ Guide the patient's fixation.

Use the external fixation target to guide the patient's visual fixation until the part you want to photograph becomes visible through the optical viewfinder (eyepiece).

- \* Position the external fixation target where the patient can fix the vision with the eye not examined.
- \* If the patient's fixation cannot be achieved with the eye not photographed, press the "LCD monitoring button"; then, select an internal fixation target using the "fixation target selection button", or use the internal fixation target (optional accessory) to guide the patient's fixation.

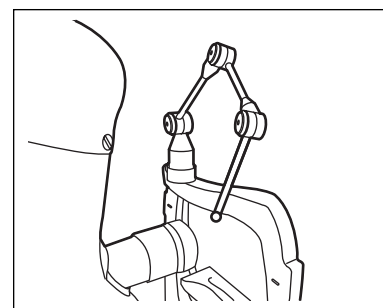

## ⑩ Adjust the focus.

Turn the "focusing knob" to adjust the focus. When you turn the focusing knob, the focus dots on the LCD monitor move left and right. Turn focusing knob so that the upper and lower focus dots come to form a straight line.

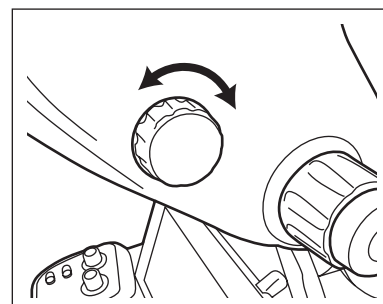

## ⚠ Notice ●●●●●

- \* The focus dots are not displayed when using the diopter compensation lens. Adjust the focus as you view the retinal image on the LCD monitor.

## ⑪ Start the timer.

Press the "Timer button" on the right side panel at the same time that fluorescein is intravenously injected to the patient.

Elapsed time is indicated on the LCD monitor. The elapsed time at the time of photography is also recorded in the photographed image.

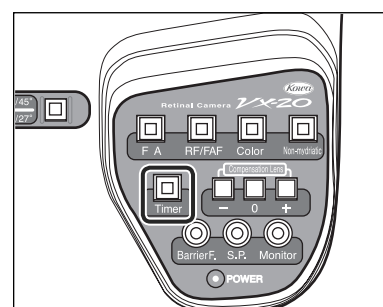

## ⑫ Insert the barrier filter.

Press the "Barrier filter button" on the right side panel and insert the barrier filter into the light path.

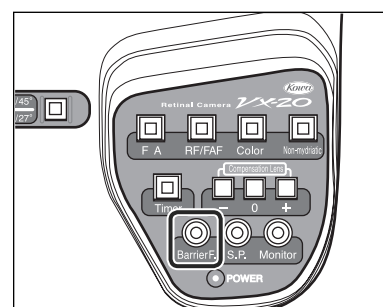

## 3 Basic usage

### ⑬ Photograph the image.

Press the “Shutter button” to activate the flash and photograph the image.

When the connection configuration in “Stand-alone” or “Network connection”, images are displayed in the preview window immediately after they are photographed.

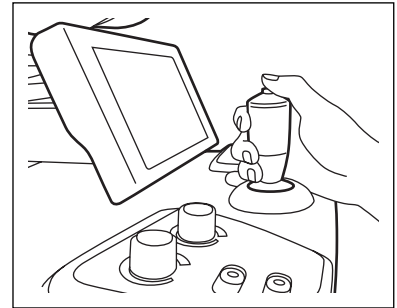

- \* Holding down the shutter button allows you to consecutively take one photograph per second. This function is useful during the initial period of the fluorescence angiography.
- \* Preview cannot be displayed quickly enough when consecutively taking a photograph each second. If you want to use this function frequently, it is recommended to set the connection configuration to “VK connection.”
- \* With the flash intensity of 300W, you may take up to 20 consecutive photographs at a speed of one image per second. After taking 20 photographs consecutively, allow approx. 1 minute without using the photography flash lamp. Otherwise the instrument may be damaged.

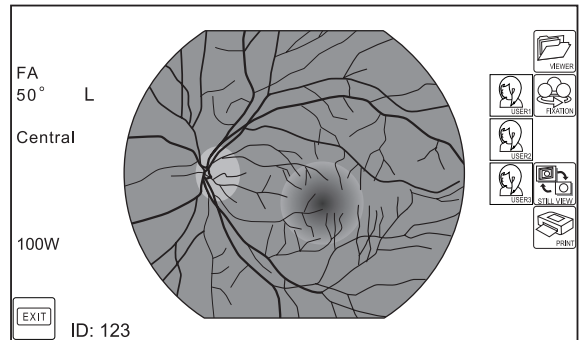

## 3.5 Viewer mode functions and procedures

This section describes various functions of the viewer mode.

You may go to the viewer mode by pressing the "VIEWER button" on the LCD monitor while in the capture mode.

You cannot take photograph in the viewer mode. Also, all buttons on the panel become disabled in this mode.

If you go to the viewer mode during Fluorescence angiography, the timer indication disappears; however, the timer continues and the timer indication resumes at the actual elapsed time when you return to the capture mode.

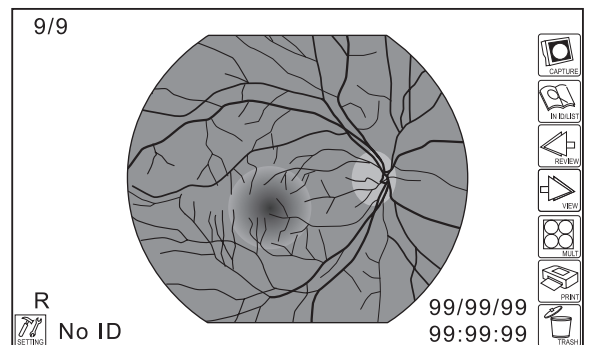

### 3.5.1 Entering an ID and switching between IDs

#### – Entering an ID –

This function is enabled while the connection configuration is in “Stand-alone” or “Network connection.”  
Enter a new ID.

Numbers 0 through 9 and the hyphen (“-”) may be used for ID.

You may enter an ID directly with the keypad on the screen or read it through a designated card reader (optional accessory) or bar code reader (optional accessory).

#### Procedure 1: Directly entering an ID

- ① Press the “Input ID button”.
- ② The current ID appears in the ID field. Check that all digits in the field are highlighted or delete the current ID using the BS/Del key; then, use the keypad and enter a new ID. Check that the new ID is displayed in the ID field and press “OK button”.

#### Procedure 2: Reading the ID through a card reader/ bar code reader

- ① Press the “Input ID button”.
- ② Read the ID through a card reader/ bar code reader.
- ③ Check the new ID is displayed in the ID field and press “OK button”.

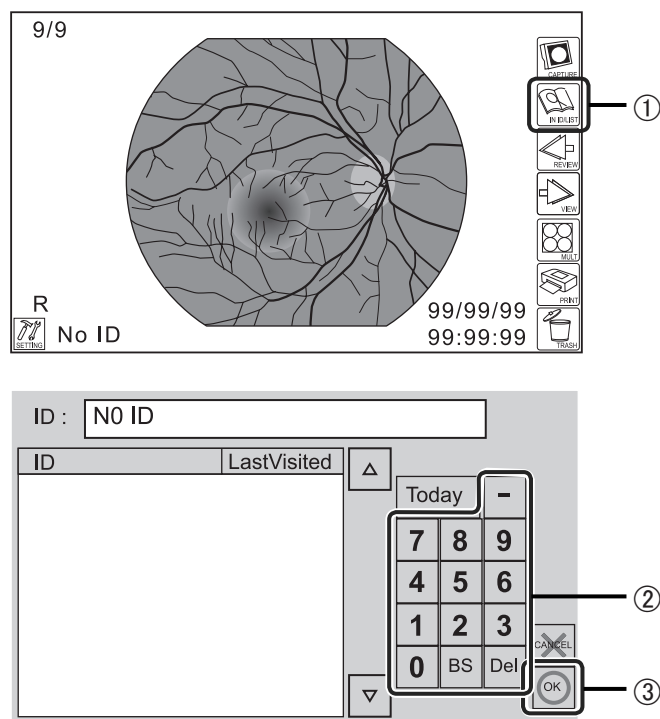

#### ⚠ Notice ●●●●●

- \* The last ID entered will be the Save/ View ID of the instrument. If you want to save or view images under a different ID, follow the procedures in “Switching to another ID” and switch to the ID you want to use.
- \* Connect a card reader or bar code reader to the instrument before pressing the “Input ID button”.
- \* A card reader or bar code reader must be configured according to its usage environment. If you are to use a card reader or bar code reader, contact Kowa or your Kowa dealer in advance.



### – Switching to another ID –

This function is enabled while the connection configuration is “Stand-alone.”  
You may switch from the current ID to an existing ID under which you want to save or view.

#### Procedure

- ① Press the “Input ID button” to go to the ID screen.
- ② Select an ID from the ID list shown in the \*\* section of the screen. The selected ID becomes highlighted.
- ③ Press “OK button”.

When more than 10 IDs are registered, use the list switching buttons to change IDs to view.

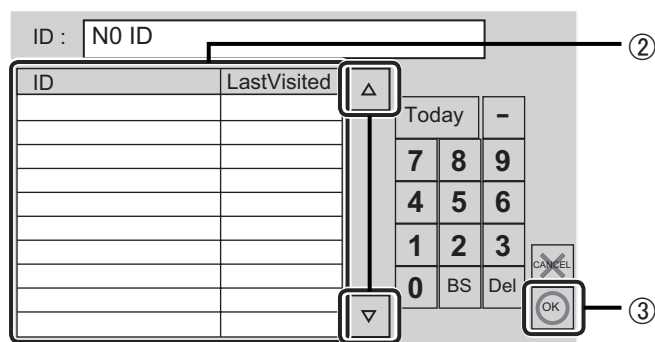

### 3.5.2 Single image display

This function is enabled while the connection configuration is “Stand-alone.”

You may view the images saved under an ID one at a time.

This function is enabled immediately after you go to the viewer mode. The most recent image saved under the selected ID is displayed.

Use the arrows on the LCD monitor to switch images; “VIEW button” for the next image and “REVIEW button” for the previous image.

When you press “VIEW button” while the most current image is displayed, the oldest image appears.

When you press “REVIEW button” while the oldest image is displayed, the most current image appears.

The total number of images saved under the ID and the photography sequence number of the image displayed are indicated on the upper left of the image.

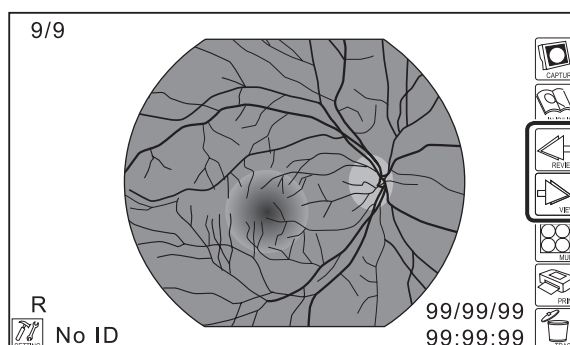

## 3 Basic usage

### 3.5.3 Multiple image display

This function is enabled while the connection configuration is “Stand-alone.”  
You may view the images saved under an ID, up to four images at a time.

#### – Four-image display –

Press the “MULT button” on the LCD monitor while on the single image display to show the four most current images saved under the same ID.

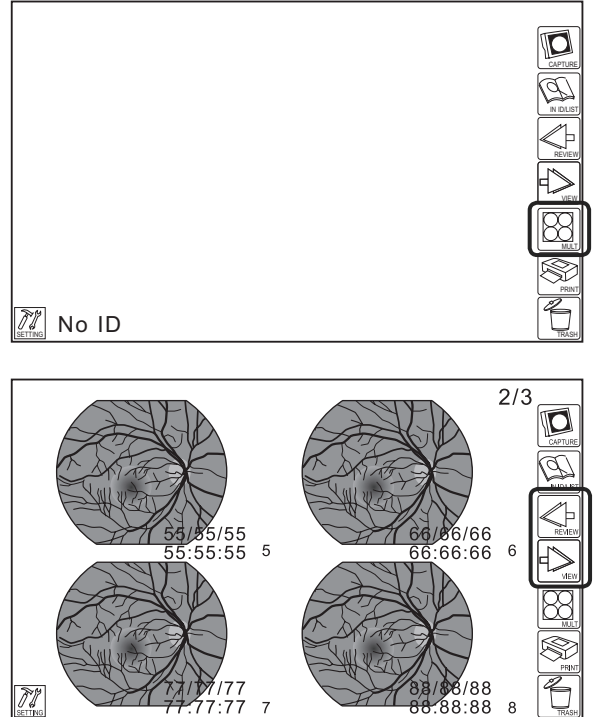

When you press “VIEW button” while on the four-image display, the four oldest images appear in one window. When you press “REVIEW button”, the next four images, including the one immediately older to the four previously on display, appear.

The total number of pages and the current page number, both of which are based on four-image display, are indicated on the upper left of the four-image display window.

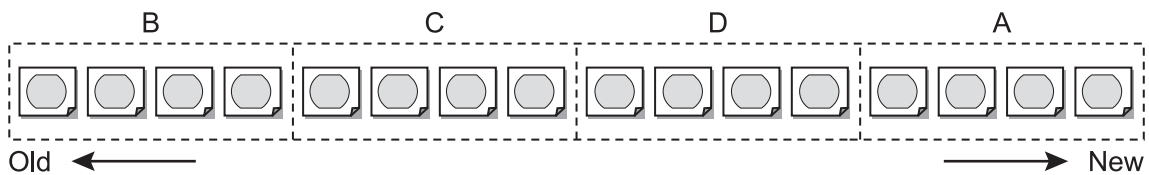

When you press the “MULT button”, four images indicated “A” in the illustration appear in a window.

Press “VIEW button” while the images A are displayed: Four images “B” appear in the window.

Press “REVIEW button” while the images A are displayed: Four images “D” appear in the window.

Press “VIEW button” while the images B are displayed: Four images “C” appear in the window.

Press “REVIEW button” while the images B are displayed: Four images “A” appear in the window.

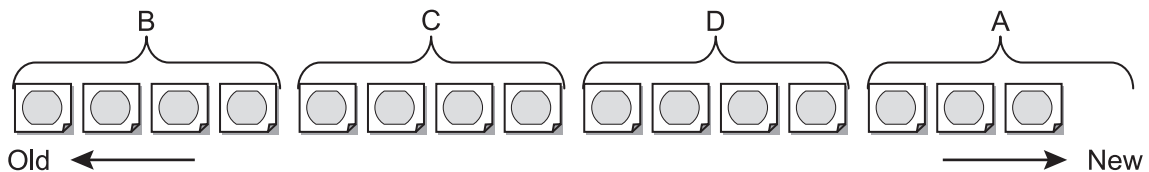

When the total number of images saved is not the multiples of 4, one to three most current images appear when you press the “MULT button.”

### – Selected image display –

While on the four-image display, press any of the images to view. “Select O” is indicated on the corner of the selected images (O is a number of your selection).

After making your selection, press the “MULT button” again to view only the selected images.

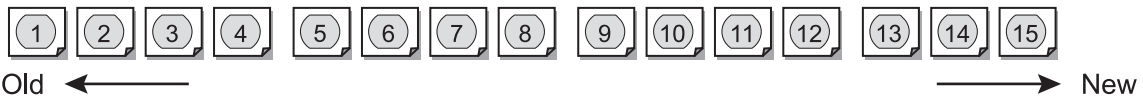
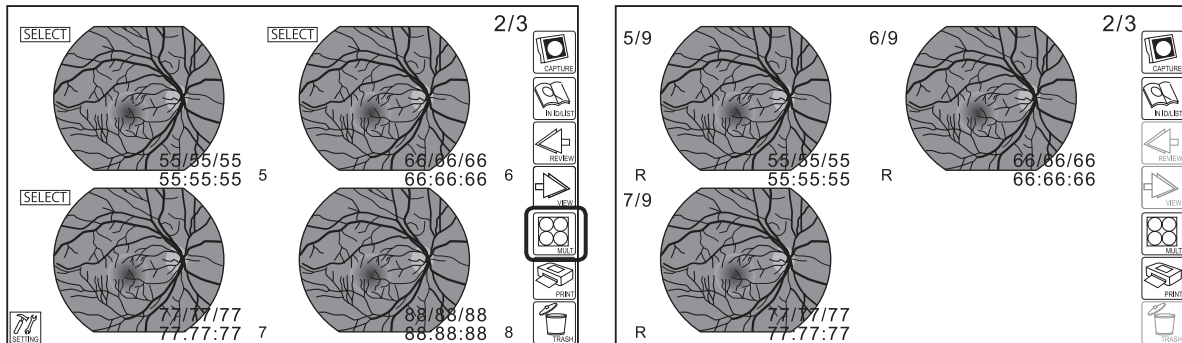

Example: When 7, 3, 11, and 14 are selected in this order

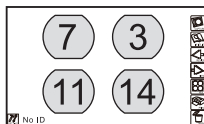

The selected images are displayed as shown above.

Example: When two images, 7 and 3, are selected in this order

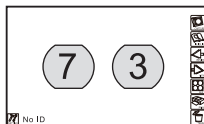

The selected images are displayed as shown above.

### – Switching back to the single image display –

While on the four-image display, tap on an image twice, to go to the single image display of the selected image.

If you press the “MULT button, while on the four-image display but there are no selected images, the most current image of the four is shown.

\* You may select up to four images.

## 3 Basic usage

### 3.5.4 Deleting photographed images

This function is enabled while the connection configuration is “Stand-alone.”  
You may delete images while viewing them.

#### – While on the single image display –

When you press the “TRASH button” while the image you want to delete is displayed, an alarm message appears. If you are certain that you want to delete the image, press “Yes”. If not, press “No.”

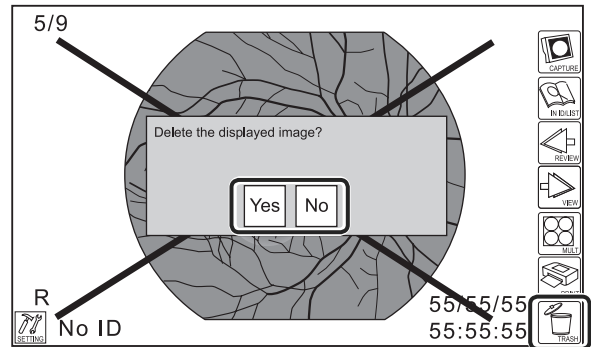

#### – While on the four-image display –

Press the images you want to delete. “Select O” is indicated on the corner of the selected images (O is a number of your selection).

When you press the “TRASH button”, an alarm message appears. If you are certain that you want to delete the images, press “Yes”. If not, press “No.”

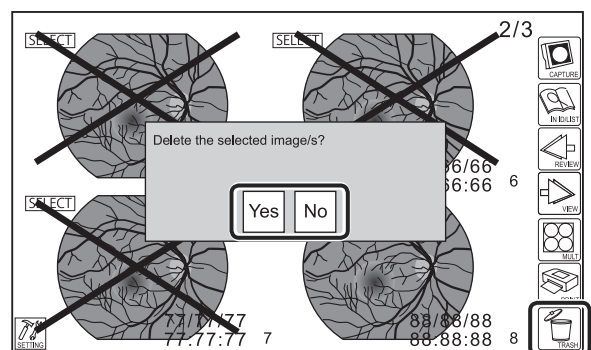

#### ⚠ Notice ●●●●●

\* Deleted images may not be recovered.

### 3.5.5 Printing photographed images

This function is enabled while the connection configuration is “Stand-alone.”  
You may print photographed images that are saved.



While on the single-image or multiple-image display, press the “PRINT button” to print the images that are shown. If on the multiple image display, the photographed images are printed as shown in the LCD monitor.

#### ⚠ Notice ●●●●●

- \* A designated printer (optional device) is required to print photographed images.

### 3.5.6 Switching to the capture mode

You may switch from the viewer mode to the capture mode.

While in the viewer mode, press the “CAPTURE button” on the LCD monitor to go to the capture mode.



## 4.1 Tilt and panning

This instrument has the tilt and panning mechanism, which is used to photograph more surrounding field in mydriatic color photography and fluorescence angiography.

### 4.1.1 Tilt

- ① Rotate the tilt lock knob to the left as you face directly to the tilt lock knob to release the lock.
- ② Turning the tilting handle to the right (as you face directly to the tilting handle) allows you to tilt the optical component in an angle of depression.
- ③ Turning the tilting handle to the left (as you face directly to the tilting handle) allows you to tilt the optical component in an angle of elevation.

#### **Point**

- ☑ The tilting mechanism has a level position, where you feel a “click” when moving the instrument. When you have finished photographing the surrounding field and return to the standard photography, return the instrument to this position.
- ☑ When the tilting angle of elevation is insufficient in order to photograph a surrounding field, you may use a higher forehead rest K9L-HR56 (optional accessory), which moves back the patient's forehead and increase the angle of elevation,

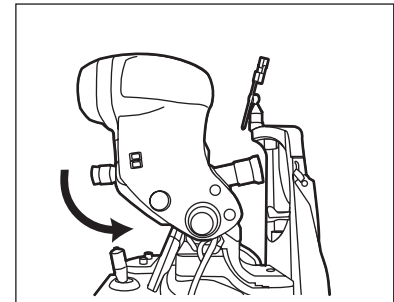
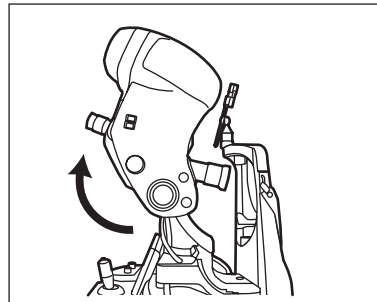
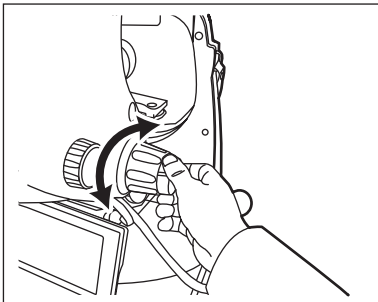
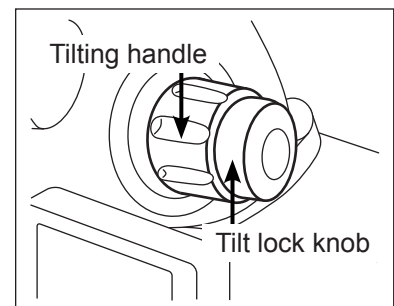

### 4.1.2 Panning

- ① Rotate the panning lock lever to the left as you face directly to the panning lock lever to release the lock.
- ② Hold the area under the focusing knobs and slowly panning it to right or left.

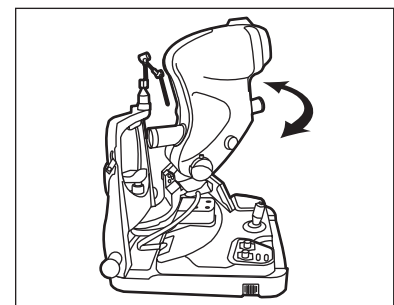
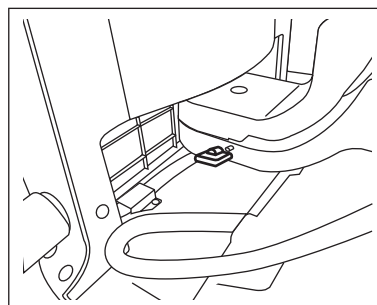
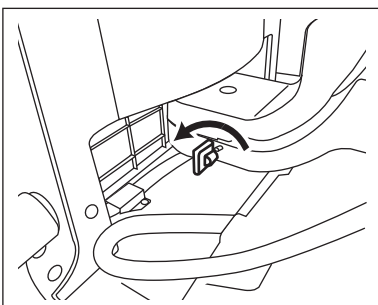

#### **Point**

- ☑ The panning mechanism has a reference position, where you feel a “click” when moving the instrument. When you have finished photographing the surrounding field and return to the standard photography, return the instrument to this position.

## 4.2 Small pupil photography

This section describes how to photograph patients with a small pupil diameter.

While this method allows you to photograph patients with a small pupil diameter, there are such disadvantages as smaller field angles or easier occurrence of a flare.

Press the “S.P. button” on the right side panel to change the pupil diameter that can be photographed. The pupil diameter that can be photographed under each photography mode is shown below.

Photography mode	Standard	S.P.	S.S.P
Mydriatic color	Φ5.5 mm	Φ4.0 mm	Φ3.5 mm
Red Free	Φ4.0 mm	×	×
FA	Φ5.5 mm	Φ4.0 mm	Φ3.5 mm
Non-mydriatic color	Φ4.0 mm	Φ3.5 mm	×
FAF (Non-mydriatic monitoring)	Φ4.0 mm	Φ3.5 mm	×
FAF (Mydriatic monitoring)	Φ5.5 mm	Φ4.0 mm	Φ3.5 mm

\* pupil of the diameter shown in the table or larger may be photographed.

Two levels of the S.P. mode is available for mydriatic color photography, fluorescence angiography, and mydriatic monitoring in FAF.

The S.P. button on the right side panel is indicated as shown below:

Normal pupil diameter : Off  
 S.P. : Lit  
 S.S.P. : Flashing

## 4 Other functions

The LCD monitor shows the approximate pupil diameter that may be photographed.

The outer circle of the double circles shown in the illustrations below is the approximate pupil diameter that may be sufficiently photographed in the current diameter setting. The inner circle is the pupil diameter that may barely be photographed in the current diameter setting. Use these circles as reference to select the suitable pupil diameter for photography.

When you select  $\Phi 3.5\text{mm}$  as the pupil diameter to be photographed, a green line appears outside the outer circle. This circle shows an area where a flare may occur during photography. Align the pupil so that the part to be photographed is within the green line.

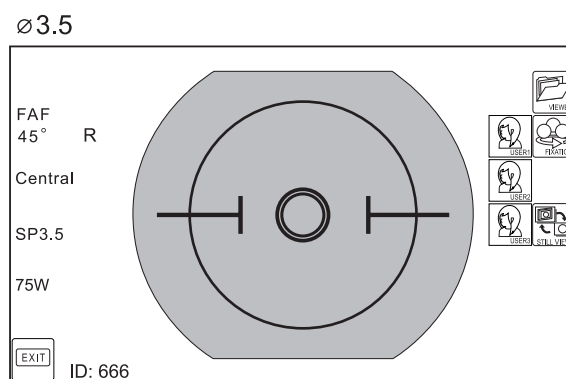
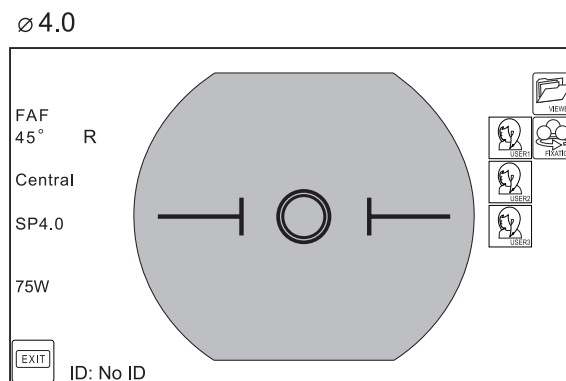
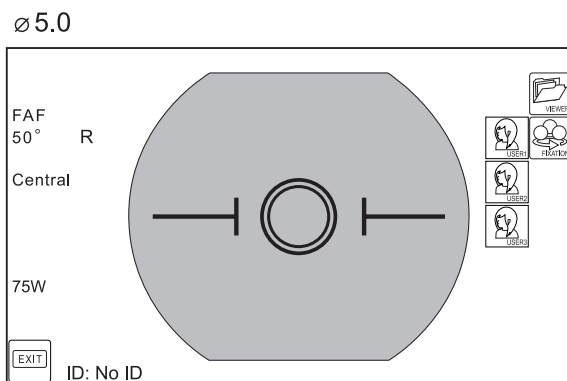



## 4.3 LCD Monitoring

This section describes how to perform alignment on the LCD monitor without using the optical viewfinder (eyepiece) during mydriatic color photography, Red Free photography, fluorescence angiography, and mydriatic monitoring in FAF.

This function eliminates the need of diopter adjustment of the optical viewfinder (eyepiece).

Also, this mode uses infrared rays instead of visible light to observe patients; therefore, patients are relieved of glaring, which facilitate smooth photography.

Pressing the “LCD monitoring button” on the right side panel switches to the LCD monitoring mode.

Pressing the “LCD monitoring button” once again switches back to the viewfinder monitoring mode.

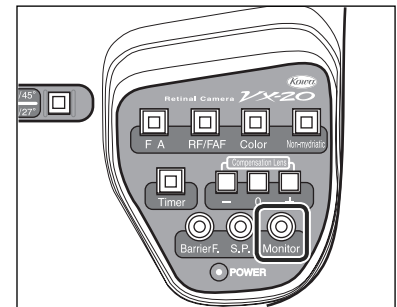

### Point

- When the patient's pupil in natural dialation is 5.5 mm or more in diameter, mydriatic color observation allows you to photograph with field angle of 50 degrees without using mydriatics . The field angle for the standard non-mydriatic color photography is 47 degrees.

### Important

- Images on the LCD monitor are not as clear as the ones in the viewfinder monitoring mode; therefore, it becomes more difficult to remove a flare or adjust focus.
- Notice that when performing LCD monitoring in the FA mode, not only a fluorescence image but also an actual captured image with infrared rays; therefore, the photographed fluorescence image differs from the image seen while performing alignment.

### Point

- The LCD monitor angle may be changed. Adjust the angle if the LCD monitor is hard to see during the viewfinder observation or while the optical head is tilted.

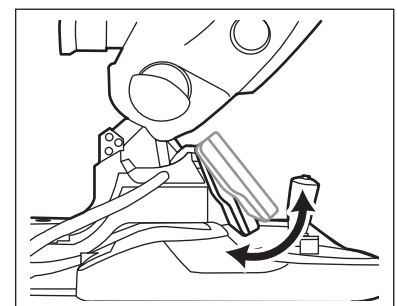

## 4.4 Switching fixation target

This instrument automatically switches to an appropriate fixation target and the position of patient's eye fixation when the photography modes are changed.

Please note that fixation targets are automatically switched according to the photography mode, not according to the state of the patient or the part required to be photographed.

This section describes how to change the fixation target and the position of the patient's eye fixation.

### Procedure

- ① Press the "FIXATION button" on the LCD monitor.
- ② Select a button from "EXT", "CENTRAL", "DISC", "MACULA", and "PERIPHERAL" buttons, which appear on the LCD monitor.

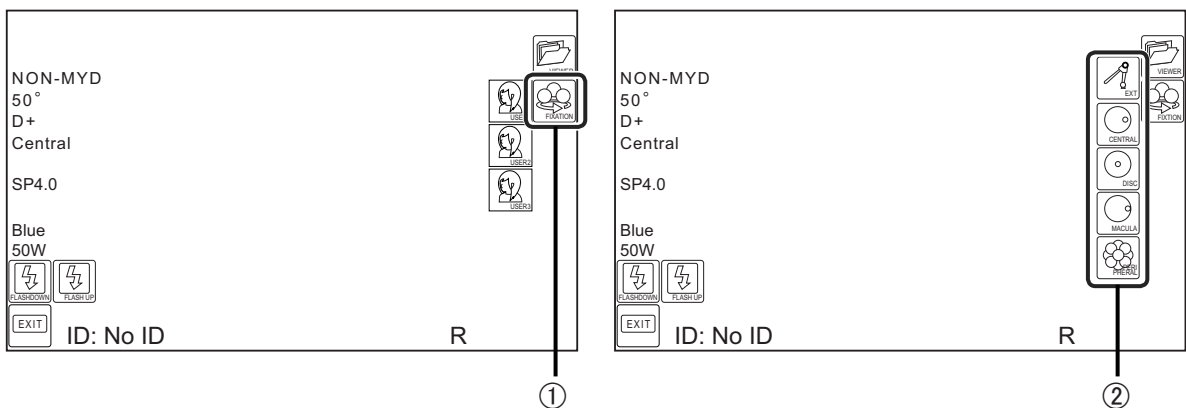

The function and main intended use of each button are shown below.

Button	Fixation target and its position	Common use
EXT	External fixation target	When you are observing under visible light or want to guide the patient's fixation to a part to be photographed.
CENTRAL	Internal fixation target: center of posterior	When you want to guide the patient's fixation under infrared ray observation. The position of the fixation target is internally fixed in the instrument; therefore, stability is increased when photographing repeatedly.
DISC	Internal fixation target: center of optic disc	
MACULA	Internal fixation target: center of macula	
PERIPHERAL	Internal fixation target: center of macula, and one of eight peripheral points (according to the setting)	When you want to perform mosaic mode photography with macula in the center under non-mydriatic observation. You may configure the settings to specify an area and sequence of photography.

For all of the above fixation targets, a red and a green lamp alternatively turns on.



### Important

- The internal fixation target is unavailable for mydriatic color photography, Red Free photography, or fluorescence angiography (observation with visible light). To use the internal fixation target in these photography mode, switch to the "LCD monitoring" mode.

### – About “Peripheral” photography –

This section describes how to switch the light position of the fixation target and how to guide the patient's fixation when “Peripheral” photography is selected.

Go to [Settings\Internal Fixation Target] to specify a photography sequence for a part to be photographed. When “Peripheral” is selected, the fixation targets turn on to guide you through the specified sequence.

The fixation target applicable for the first part to be photographed is lit immediately after selecting “Peripheral”. The screen shows the guiding direction for the patient's fixation; guide the patient in the direction exactly as indicated.

Example:

9	2	3
8	1	4
7	6	5

Setting

- 1) To photograph the part No.1, “Center” is indicated on the LCD monitor.  
You would say to the patient, “Please look at the luminous dot in the center.”
- 2) To photograph the part No.2, “Up” is indicated on the LCD monitor.  
You would say to the patient, “Please look at the luminous dot above the center.”
- 3) To photograph the part No.3, “Left up” is indicated on the LCD monitor.  
You would say to the patient, “Please look at the luminous dot on upper left.”

Once an image is photographed, the fixation target changes according to the next part to be photographed. Continue to guide the patient's fixation and photograph images.

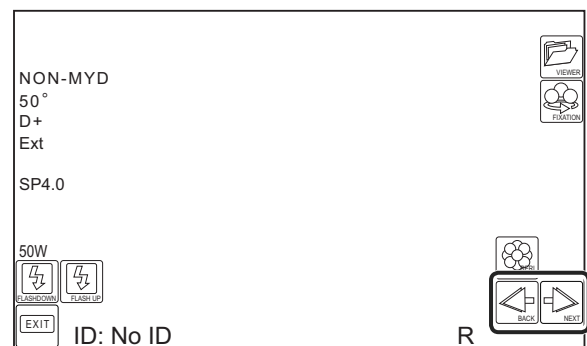

If the currently set photography sequence includes parts unnecessary to be photographed or if you want to recapture an already-photographed part, you may use the arrow buttons (“NEXT button” and “BACK button”) on the LCD monitor to change the sequence.

Press “NEXT button” to switch to the fixation target for the part to be photographed next.

Press “BACK button” to switch to the fixation target for the part previously photographed.



**Point**

- The internal fixation target may not be visible to the patient immediately after switching the position. First, guide the patient's fixation to the general area indicated on your monitor; then, instruct the patient to look at the luminous dot as it becomes visible during the alignment process.

## 4 Other functions

### – About the internal fixation target (optional accessory) –

Use the internal fixation target (optional accessory) if you want to record the patient's fixation position in the photographed images.

#### Attaching the internal fixation target

- 1) Remove the cover of the internal fixation target socket on the optical component.

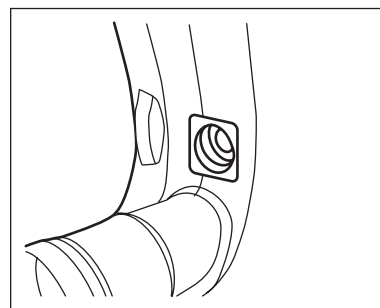
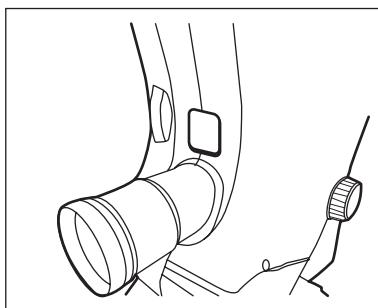

- 2) Remove the protective tube of the internal fixation target.

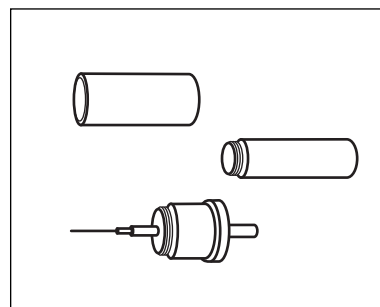

- 3) Screw the internal fixation target into the socket on the optical component.

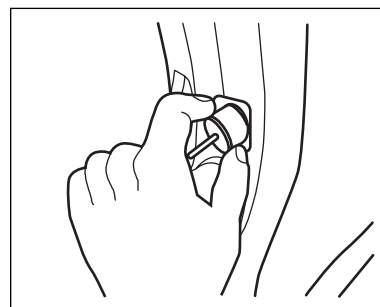

#### ⚠ Notice ●●●●●

- \* When removing the cover from the internal fixation target, be careful not to bend the body of the fixation target.

## 4.5 Additional adjustment of the flash intensity(+5 or more, -5 or less)

You may use this function to compensate the flash intensity beyond the compensation range allowed with the flash intensity compensation knob.

When the flash intensity compensation knob is turned to +5, a "FLASH UP button" appears on the LCD monitor that allows adjustment to higher flash intensity. Pressing the button once increases the flash intensity by one level. Similarly, when the flash intensity compensation knob is turned to -5, a "FLASH DOWN button" appears on the LCD monitor that allows adjustment to lower flash intensity.

These buttons allow adjustment to the maximum flash intensity of 300W and the minimum flash intensity of 0.6W. If you change the setting on the flash intensity compensation knob while making an additional adjustment to flash intensity, the adjustment made with the flash intensity compensation knob precedes.

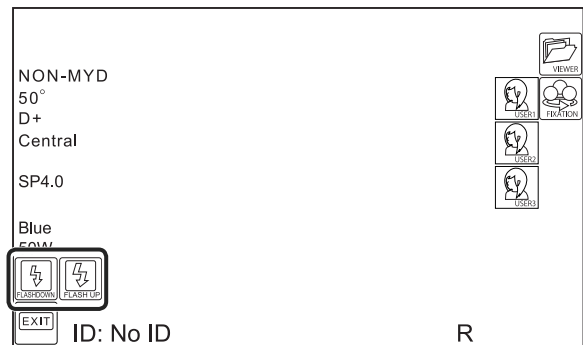

## 4.6 Blue/Brown button

The Blue/Brown button allows you to set the flash intensity suitable for the iris pigment.

The standard setting at the factory default is "Brown". When you press the Blue/Brown button, "Blue" appear on the screen and the flash intensity reduces by approximately 2.5 EV.

The new setting is enabled until you press the button again.

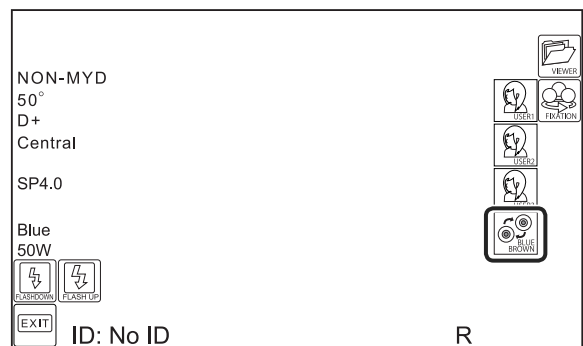

## 4.7 Customize button

"Customize buttons" allow you to easily switch to preset camera sensitivity, aperture size, and flash intensity magnification.

Three customize buttons are available. For the methods for changing the defaults, effects and targets, and setting values, refer to **5.4.2 Customize button**.

"Customize buttons" are enabled at any time during the capture mode.

Some photography modes, however, may not allow certain settings.

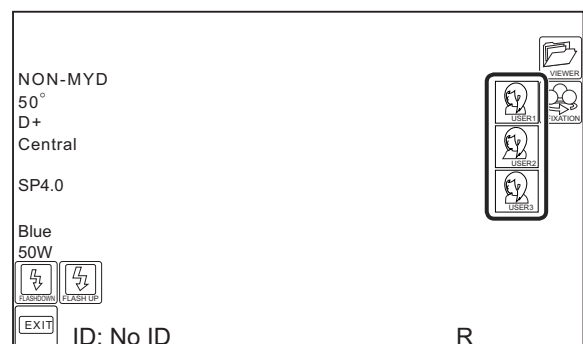

### 4.8 Power saving function

When the buttons on the operation panel and LCD monitor are not operated for a certain period of time (approximately 10 minutes), the instrument goes into the power saving mode.

During the power saving mode, the Power lamp is lit in green while all other lamps, such as LED lamps, observation lamps, photography lamps, and LCD monitor backlight, are turned off. All internal functions, except for the ones required at minimum, are also turned off during this time.

The instrument recovers from the power saving mode when you press a panel button or touch the LCD monitor.

### 4.9 Recalling and printing images

This function is enabled while the connection configuration is “Stand-alone.”

#### – Recalling an image –

When you want to examine an image closely after preview is complete, you may recall the previewed image by pressing the “STILL/VIEW button” on the LCD monitor.

The recalled image remains on the LCD monitor until the “STILL/VIEW button” is pressed again.



#### – Printing an image –

A recalled image may be printed through a printer connected to the instrument.

Press the “PRINT button” that appears in the recalled image to print.

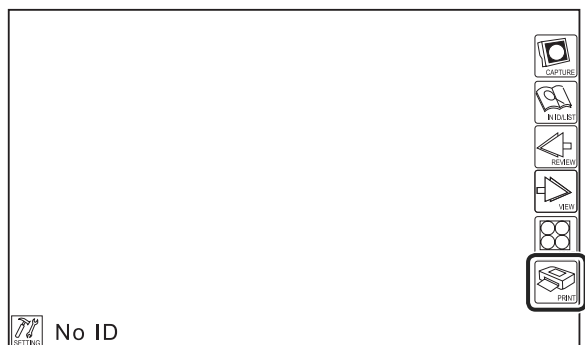

#### ⚠ Notice ●●●●

- \* Deleted images may not be recovered.

## 5.1 Main

### 5.1.1 Monitor brightness

In this tab, you may adjust the brightness of the LCD monitor, from level 1 through 10 with an increment of one.

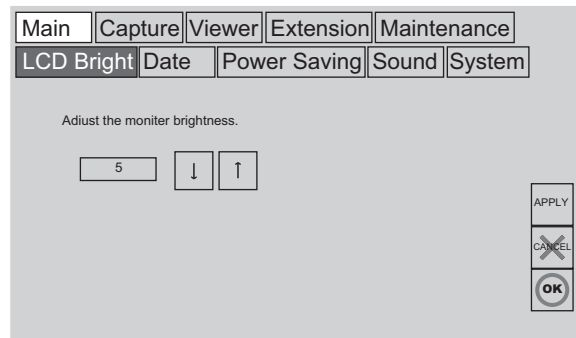

### 5.1.2 Date

In this tab, you may set the date format and delimiter as well as adjust the date and time.

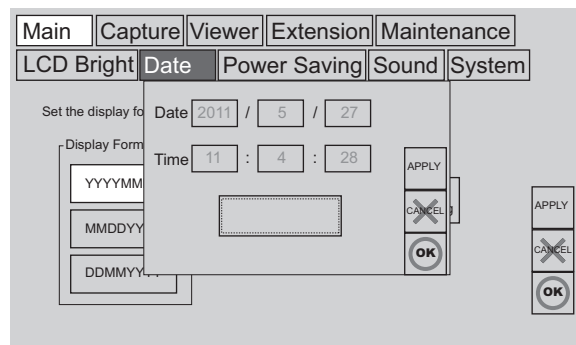
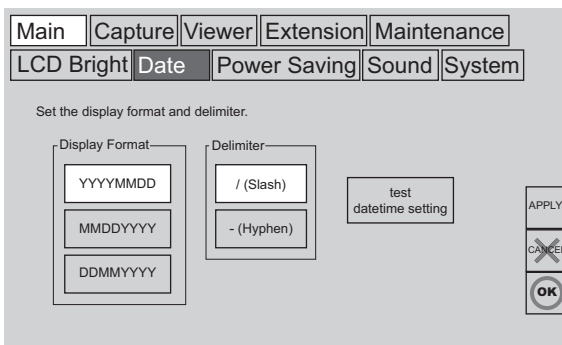

Select "YY(Year)MM(Month)DD(Day)" as the format. You may select a slash or a hyphen as the delimiter to separate year, month, and day. When you press "Date button", the setting dialog box appears. When you press the "Change the setting button", control buttons appear next to each field. Use the control buttons to set the date and time.

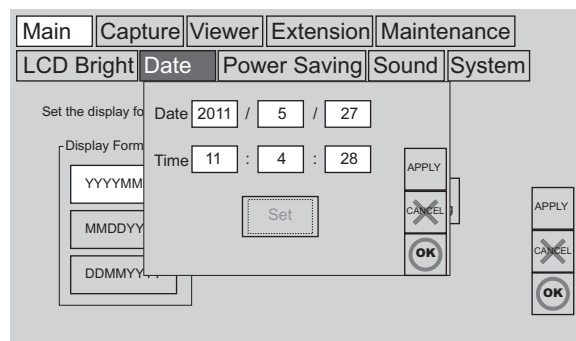

### 5.1.3. Power saving mode

In this tab, you may configure the settings for the power saving mode.

**ON:** When this instrument is not operated for approximately 10 minutes, it will resume the power saving mode (LCD backlight is turned off; halogen lamp, panel LED, and other lamps are turned off, and charging function is suspended).

**OFF:** The instrument will not resume the power saving mode.

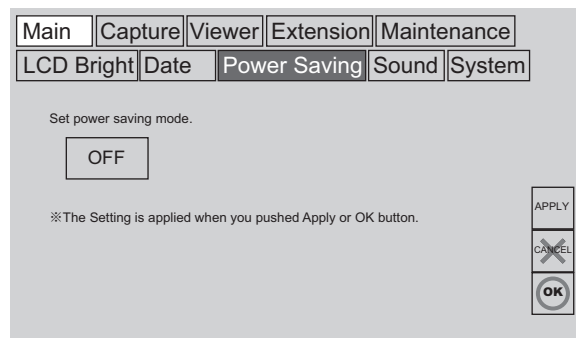

## 5 Setting

### 5.1.4 Operation sound

In this tab, you may enable or disable the operation sound used in functions such as timer and alarm.

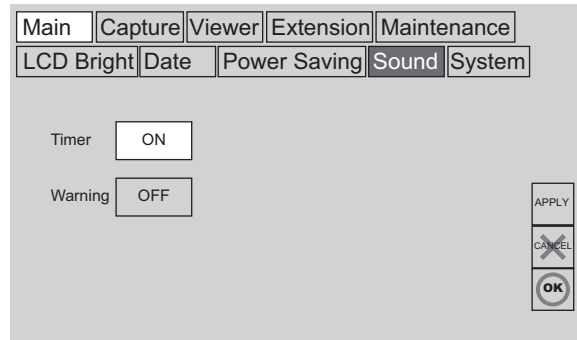

### 5.1.5 System connection configuration

In this tab, you may set the system connection configuration of this instrument.

Stand-alone: The instrument is used in stand-alone.

VK connection: The instrument is connected to Kowa VX series.

Network connection: The instrument is connected to external equipment.

Select a button that suits the use of the instrument.

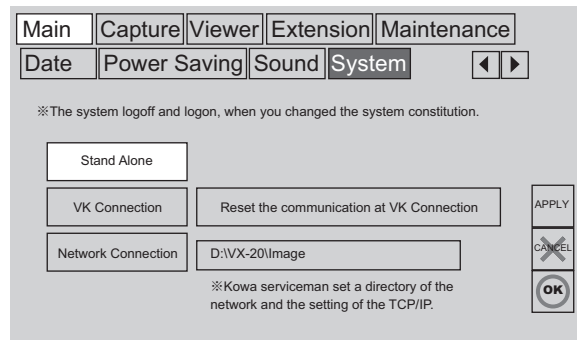

#### ⚠ Notice

- \* When using the instrument in Stand-alone, be sure to insert a compact flash memory card.
- \* When using the instrument in VK connection, use USB cable 1(A—mini-B type)(K9L-SC56A) to connect this instrument and a VK series model.
- \* When using the instrument in Network connection, make sure a network path is specified. If a network path is not specified, please contact Kowa or Kowa dealer representative.



## 5.2 Capture

### 5.2.1 Flash intensity

Increments of flash intensity: You may set 0.3EV or 0.5EV to calibrate the increment of increase/decrease of the flash intensity compensation knob.

Flash intensity indication: The flash intensity may be displayed on the LCD monitor as the position of the flash intensity compensation knob (in  $\pm$ ) or as a value in watt.

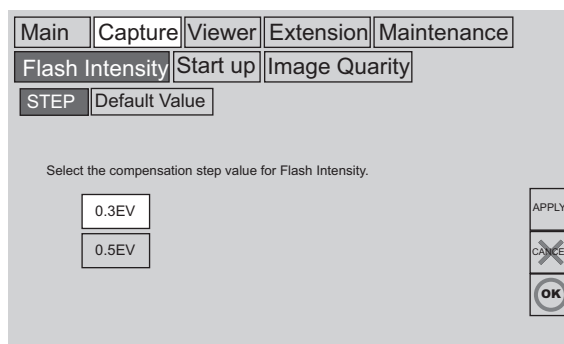

Reference flash intensity: You may set the reference flash intensity of each photography mode, which is the flash intensity at the zero (0) position of the flash intensity compensation knob, at  $\pm 4$  levels.

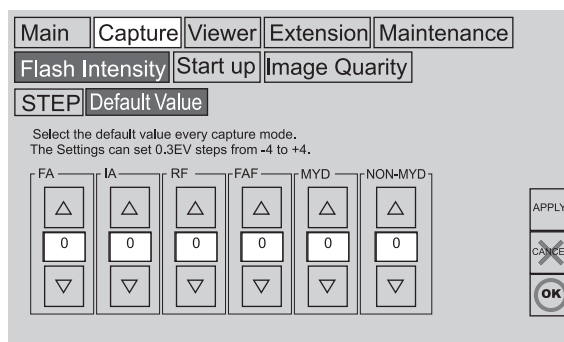

### 5.2.2 Start-up mode

In this tab, you may set the “photography mode settings button” operation regarding the photography mode at the time of start-up.

Start-up photography mode: The instrument is in either mydriatic or non-mydriatic photography mode at start-up.

RF/FAF button: The instrument is in either Red Free or FAF photography mode when the “RF/FAF switching button” is pressed for the first time after start-up.

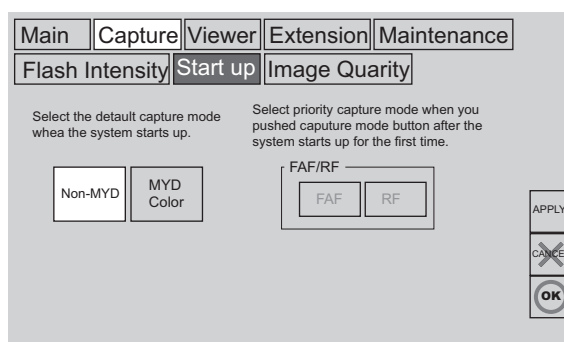

## 5 Setting

### 5.2.3 Image quality/color

This function is enabled while the connection configuration is in “Stand-alone” or “Network connection.”

- \* In “VK connection”, the image quality and color settings for the photographed images are configured in the VK series, which allows more detailed settings. To achieve images that are close to what you want, using the instrument in VK connection is recommended.

**Image quality/color:** You may adjust the quality and color of the photographed images in color (mydriatic color and non-mydriatic color) photography.

**Size and compression rate:** You may set the size and compression rate of the photographed images. A common size and compression rate settings are used for color photography, Red Free photography, and FAF photography. A separate set of settings are available for Fluorescence angiography.

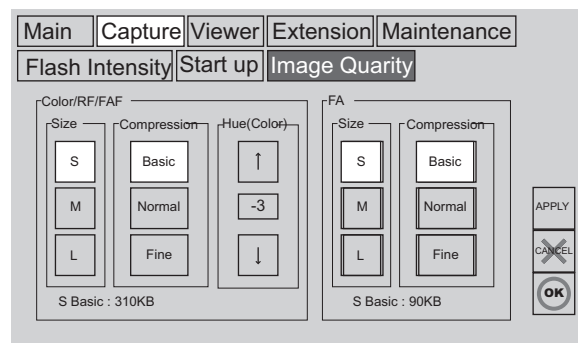

## 5.3 Viewer

### 5.3.1 Preview

You may set the length of time during which preview is displayed on the LCD monitor immediately after photographing when the instrument is in Stand-alone or Network connection.

A set of settings for color, Red Free, and FAF photography and another set for Fluorescence angiography are available.

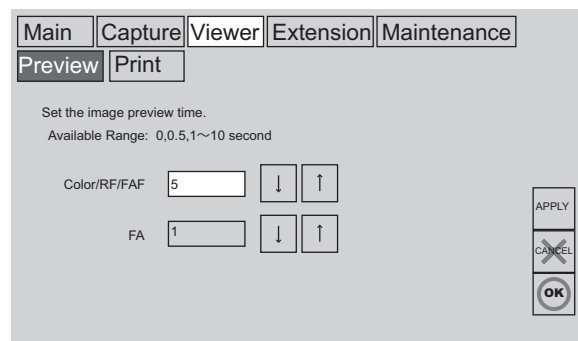

### 5.3.2 Print

When Stand-alone is selected for the connection configuration, you may print photographed images using a printer connected to this instrument.

You may set whether photographing conditions are printed in the margin.

**Items that may be set:** number of images (Image No. within an ID/total number of images within an ID), flash intensity (W), field angle, right or left eye, ID, photographed date and time, internal fixation target

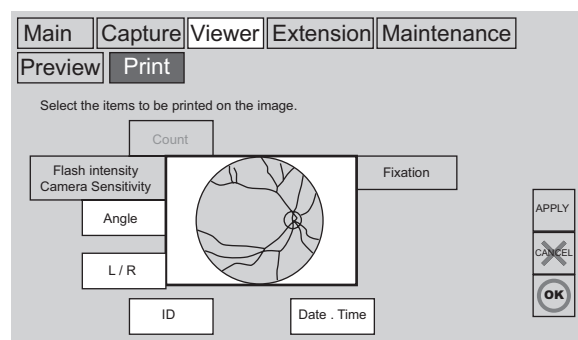

## 5.4 Advanced functions

### 5.4.1 Internal fixation target

In this tab, you may configure the internal fixation target settings regarding “Peripheral”.

You may set the lighting sequence of the fixation targets to be lit and whether the sequence for the right eye should be mirrored for the left eye.

#### – Setting the photographing sequence –

The lighting sequence is specified by setting the parts to be photographed in the right eye.

- A: Current sequence in the right eye
- B: Current sequence in the left eye
- C: Numerical pad for entering a new sequence
- D: Mirror button

The numbers shown in “C: Numerical pad for entering a new sequence” signifies the parts to be photographed. Press the numbers in the sequence you want to register a new photographing sequence. You may enter any number of digits up to nine. When you have entered the sequence, press “OK”. The new sequences will be reflected in A and B.

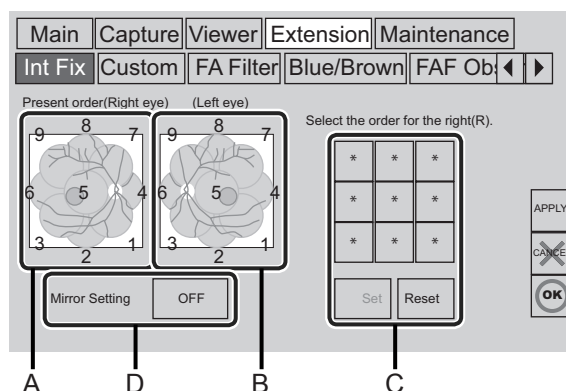

#### – Setting the mirror function –

When the “mirror button (D)” is pressed, the sequence entered for the left eye will be mirrored for the right eye photography.

When the “mirror button (D)” is not pressed, exactly the same sequence entered for the left eye will be copied for the right eye photography.

### 5.4.2 Customize button

“Customize buttons” allow you to easily switch to a preset combination of camera sensitivity, aperture size, and reference flash intensity.

In this menu, you may specify a separate set of settings for each customize button.

Press a button number for which you want to set and press the items you want to specify. If the button looks “pressed down”, it is selected.

Press “APPLY” button or “OK button” to store the settings in memory.

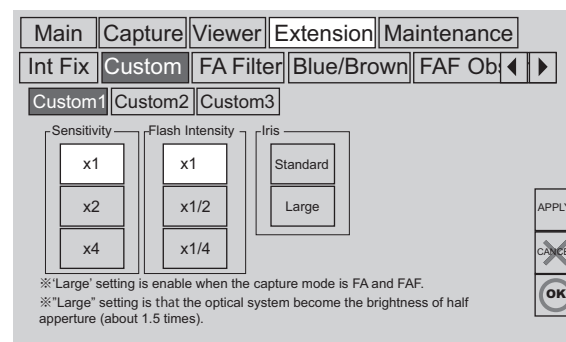

## 5 Setting

### Items to set

Camera sensitivity : photography sensitivity of the camera. X1: Standard, X2: two fold, X4: four fold  
As the setting is changed from X1 to X4, photography with low flash intensity becomes possible, but the image quality is compromised.

Aperture size : the size of the camera aperture.  
Standard : When the customize buttons is pressed, the aperture remains the standard size.  
Large : When the customize buttons is pressed, the aperture is switched to a size larger than the standard aperture. When the photography mode is in non-mydriatric, mydriatric color, or Red Free, however, the aperture size remains in the standard size.

Flash intensity : Reference flash intensity.  
X1 : Remains in the standard setting.  
X1/2 : 1/2 of the standard setting.  
X1/4 : 1/4 of the standard setting.

### Examples of customize buttons (target use of the factory default settings)

Settings of each button and its effects and target use are shown below.

Button	Camera sensitivity	Aperture	Flash intensity	Effect and target use
Custom 1	×2	Standard	×1	Relatively bright-color images are achieved without increasing glaring for patients. The image quality is not overly compromised.
Custom 2	×4	Large aperture	×1	Very bright-color images are achieved without increasing the glaring for patients, but the image quality is compromised and a flare increases. This setting is effective when the flash intensity is insufficient during fluorescence photography.
Custom 3	×4	Standard	×1/4	Images as bright as the standard mode are achieved while reducing glaring for patients. The image quality is compromised. This setting is effective when you want to separately photograph images in the low flash intensity.

#### 5.4.3 FA filter

With the standard setting, when FA photography mode is selected, the exciter filter is inserted in the light path; when the filter button is pressed, the barrier filter is inserted. The setting is “After” as the factory default.

If you want to insert the barrier filter first and then exciter filter as the FA button is pressed, select “Before” to change the setting.

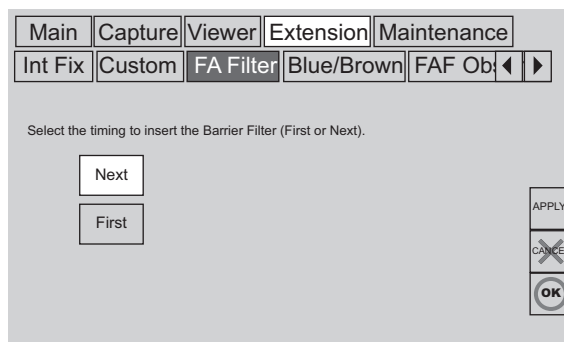

#### 5.4.4 Blue/Brown

You may select whether “Blue” or “Brown” is enabled at the time of start-up.

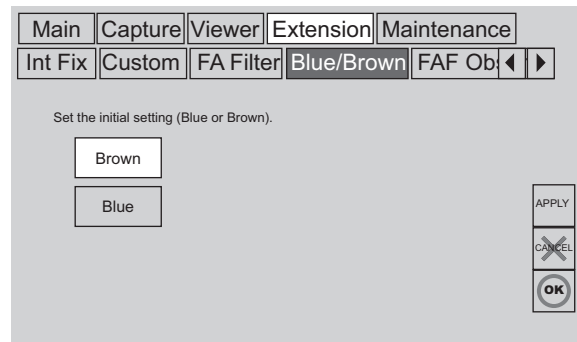

#### 5.4.5 FAF observation

The FAF observation mode, which is usually used for the LCD monitoring of non-mydratic state, also allows observation of mydratic state through the optical viewfinder (eyepiece).

This function may be set when you purchase and apply the FAF options.

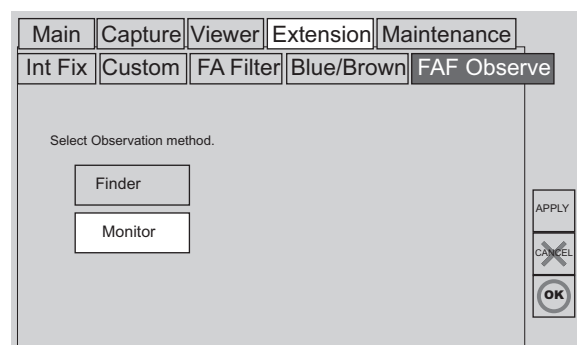

## 5.5 Maintenance

### 5.5.1 Making a backup copy of compact flash memory card

You may make a backup copy of the data saved in the compact flash memory card.

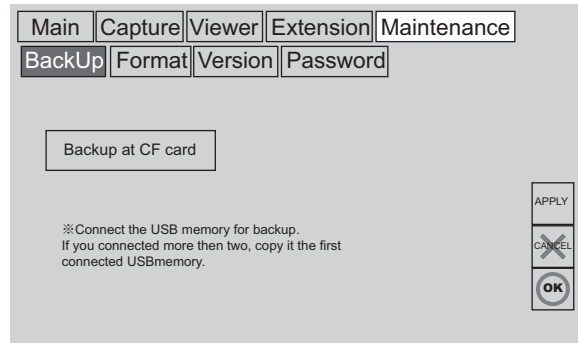

**Notice**

- \* When more than two backup media are connected, the one connected to the instrument first precedes the other.
- \* This function is enabled while the connection configuration is in "Stand-alone" or "Network connection."

### 5.5.2 Formatting a compact flash memory card

In this tab, you may format a compact flash memory card connected to the instrument.

- \* This function is enabled while the connection configuration is in "Stand-alone" or "Network connection."

If a password is set according to "5.5.4 Setting a password", you will be asked to enter the password

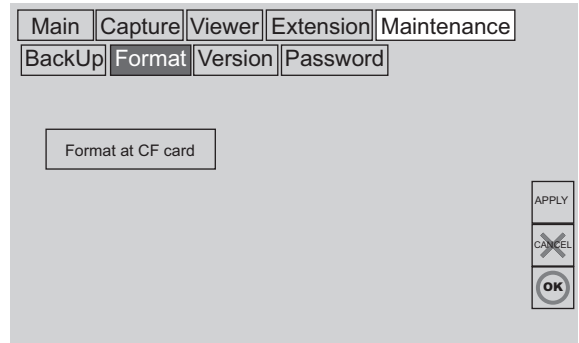

### 5.5.3 Version information

This tab shows the instrument's serial number and the versions of applications installed.

### 5.5.4 Setting a password

You may set so that a password is required when making a backup copy or formatting a compact flash memory card.

Select "Password" tab. 5.5.4\_1  
Press "Set a password" button.

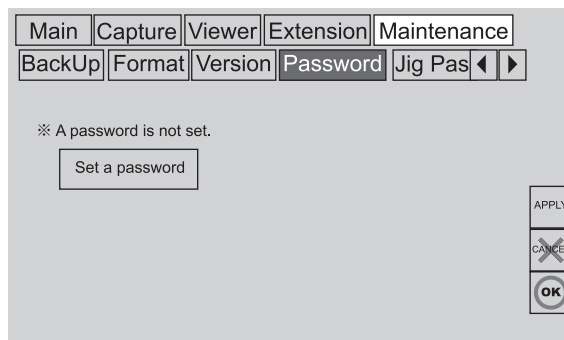

5.5.4\_1

The window shown in 5.5.4\_2 appears.  
Enter a password in the "New Password" field and press "OK" next to it.  
Enter the same password for confirmation in the "New Password (Again)" field and press "OK" next to it.  
If the confirmation password is entered correctly, the new password is set.

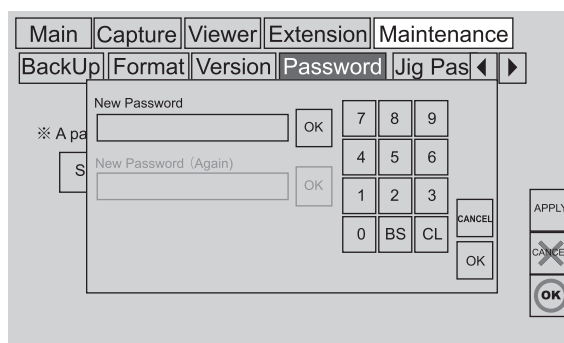

5.5.4\_2

Once the password is set, the window shown in 5.5.4\_3 appears whenever the "Backup tab" or the "Format" tab is pressed. The backup and formatting functions are enabled only when the correct password is entered.

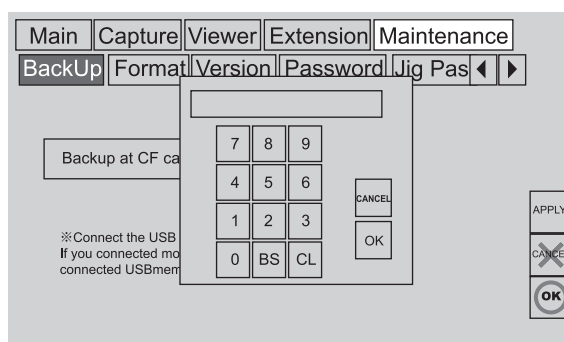

5.5.4\_3

This section describes troubleshooting procedures to solve problems you may encounter. Look for the applicable symptom from those shown in the following list and apply the applicable remedy. When the described remedy did not eliminate the symptom or you encountered a symptom that is not listed, please contact Kowa or your Kowa dealer.

Abnormal performance of the instrument		
Symptom	What to check · State of equipment	Remedy
The observation illumination lamp does not illuminate.	Non- mydriatic mode is enabled.	Change to mydriatic mode.
	LCD monitoring mode is enabled.	Change to viewfinder observation.
	Observation light intensity control knob is in the minimum position.	Turn the observation light intensity control knob to the 10 o'clock position.
	It is in the power saving mode.	Press any button on the operation panel.
	Is the illumination lamp properly attached?	Review if the illumination lamp is attached properly.
	The illumination lamp is burned out.	Replace the illumination lamp. See <b>7.4.1</b> .
The shutter button cannot be pressed.	Compact flash memory card is not inserted (in stand- alone).	Insert the compact flash memory card.
	The cable is pulled out (inVK connection).	Connect the cable.
	Viewer mode is enabled.	Enable capture mode.
The photography flash lamp does not illuminate.	Is the flash lamp properly attached?	Review the attachment of the flash lamp.
	The flash lamp is white and cloudy.	Replace the flash lamp. See <b>7.4.2</b> .
The observation image is not displayed on the LCD monitor.	Is mydriatic color mode/ RF mode/ FA mode/ finder observation mode for FAF enabled?	Enable non-mydriatic mode or LCD monitoring mode.
	Is observation light intensity control knob at the minimum position?	Turn the observation light intensity control knob to the 10 o'clock position.
	Is it soon after the power is turned on?	Wait until boot-up completes. (It takes about 40 seconds from turning on the power.)
	It is in power saving mode.	Press the button on the operation panel.
	The error message EPC02 was displayed.	Turn off the power and stop using.
Nothing is displayed on the LCD monitor.	Is it in the power saving mode?	Press a button on the panel.
Operation from the LCD monitor is disabled.	The system configuration is not "Stand-alone".	Many functions in Viewer mode is disabled during "VK connection" and "Network connection".
	The error message EPC09 is displayed.	Turn off the power and stop using.



Abnormal performance of the instrument		
Symptom	What to check · State of equipment	Remedy
The button different from the pressed button reacts during LCD monitor operation.	It is out of calibration.	Calibration must be performed.
You see nothing when you look into the viewfinder.	Non-mydratic mode is enabled.	You cannot observe from the viewfinder in non-mydratic mode.
	LCD monitoring mode is enabled.	Press the LCD monitoring button to change to the viewfinder monitoring mode.
The focus dot and the working dot are not displayed.	Alignment of the retinal camera is not correctly adjusted.	Align the retinal camera correctly.
	The ON/OFF switch is off.	Turn on the focus dot switch or the working dot switch.
	The diopter compensation button is turned to “+” or “-”.	Focus dots and working dots are not displayed when the diopter compensation lens is inserted.
	Is illumination light for monitoring too bright?	When the retinal image is bright, focus dots and working dots may be lost. Decrease the amount of illumination light for monitoring.
The external fixation target does not illuminate.	Is internal fixation target enabled?	The external fixation target and the internal fixation target do not illuminate at the same time. Select the external fixation target at the fixation target selection button.
	It is in the power saving mode.	Press a button on the operation panel to cancel the power saving mode.
The alarm does not sound.	Is alarm sound of the timer turned off?	Turn on the alarm sound of the timer in the setting. See 5.1.4.
All LED on the operation panel turn on and off.	EHD07 or EHD08 is displayed.	Turn off the power and stop using.

## 6 Troubleshooting

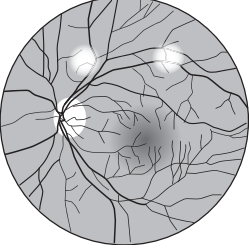
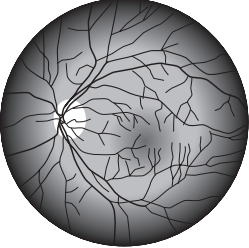
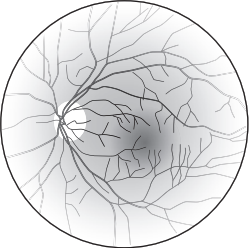
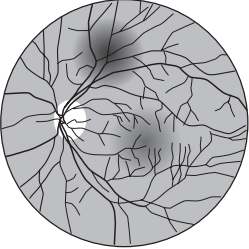
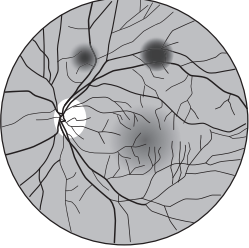
Abnormality in captured images		
<p>Images show white shadow spots at the same places.</p> 	<p>Is there dust on the objective lens?</p>	<p>Clean the objective lens. See 7.3.1.</p>
	<p>Is the objective lens contaminated by tears etc.?</p>	<p>Clean the objective lens. See 7.3.1.</p>
	<p>Are the eyelashes of the patient in front of the eye?</p>	<p>Make sure that the eyelashes do not come in front of the pupil.</p>
<p>Image's peripheral area becomes darkened.</p> 	<p>Is the digital camera located too far from the patient's eye?</p>	<p>Align the retinal camera correctly.</p>
<p>Image's peripheral area becomes whitened.</p> 	<p>Is the digital camera located too close to the patient's eye?</p>	<p>Align the retinal camera correctly.</p>
<p>Image is locally too dark.</p> 	<p>Is the pupil of the patient's eye sufficiently dilated?</p>	<p>Try small pupil mode. If it is less than the pupil diameter guideline, the center of the images becomes dark.</p>
<p>Images show black shadow spots at the same places.</p> 	<p>—</p>	<p>It is necessary to clean the inside of the camera. Contact Kowa or your Kowa dealer.</p>

Error message		
Error code	Description	Remedy
EPC01	Failure of the camera for image capturing	Turn off the power and stop using.
EPC02	Failure of the camera for observation	Turn off the power and stop using.
EPC03	Failure of the CF memory card	Replace the CF memory card.
EPC04	The CF memory card is not inserted.	Insert the CF memory card.
EPC05	Insufficient capacity of the CF memory card	Replace or format the CF memory card.
EPC06	Failure of the CF memory card	Replace the CF memory card.
EPC07	Abnormality of the internal circuit (communication)	Turn off the power and stop using.
EPC08	Abnormality of the internal circuit (battery)	Turn off the power and stop using.
EPC09	Abnormality of the touch panel	Turn off the power and stop using.
EPR01	The printer is not connected.	Connect the specified printer.
EPR02	Out of paper	Replenish the printer paper. (Replenish according to the manual of the printer.)
EPR03	Out of ink	Replenish the printer ink. (Replenish according to the manual of the printer.)
EPE01	Connection of any uncertain peripheral equipment	Do not connect equipment which is not specified by Kowa.
EPE02	Insufficient capacity of backup memory	Replace the backup memory.
EHW01	Failure of an optical unit (ring slit)	Turn off the power and stop using.
EHD07	Abnormality of the internal circuit	Turn off the power and stop using.
EHD08	Abnormality of the internal circuit	Turn off the power and provide the power supply for the sole use of this instrument. If this error occurs after restart, stop using.
EHD09	Abnormality in communication with outside PC	Reconfirm the connection of the system.

The retinal camera is a precision instrument and daily maintenance and inspection may affect the imaging results. Please read this section carefully in order to use this instrument correctly and safely.

## 7.1 Daily maintenance

- 1) Close the application of the main unit when the photographing is finished, and make sure to turn off the power switch. Place the lens cap on the objective lens, set the panning lock and the optical head base lock, and place the dust cover over the instrument.
- 2) Check that no dust, debris, finger print, or body fluid is found on the objective lens. Confirm that the objective lens is clean before you use the instrument. Confirmation of dirt is easier in mydriatic color mode with observation light intensity adjusted to visible light.
- 3) Clean the dirt of this instrument according to routine cleaning method.
- 4) If it is not used for a long period, unplug the power cord for safety. When the instrument has not been used for a long period of time, confirm if any errors are in each setting of this instrument.



### Important

- If the retinal camera in a cool room is suddenly moved to a warmer room, or if the room in which the instrument is located is heated rapidly, the objective lens and/or internal lens may be fogged. Wait for a while until the lens is clearly defogged before starting photographing. Or, images may be out of focus.
- When condensation occurs repeatedly, lenses may get moldy. When such a case has occurred to you, contact Kowa or your Kowa dealer.

## 7.2 Daily inspection

Inspect this instrument in accordance with “KOWA VX-20 daily inspection table” below.

KOWA VX-20 daily inspection table		
Inspection items	Procedure	Acceptability criteria
Plates and labels	Visually verify that plates and labels are readily readable and not contaminated.	Plates and labels are readable
Exterior	Visually verify that exterior components have no flaw, crack, deformation or rust.	There is no flaw, crack, deformation or rust.
Power supply cable	Visually verify that there is no flaw or damage.	There is no flaw or damage.
Cable between Power supply unit and optical component		
Cable between the panel and the panning arm		
Cable between the panning arm and optical component		
Cable between the panning arm and LCD		
USB cable 1 (only during operation)	Visually verify that there is no flaw or damage.	There is no flaw or damage.
	Visually verify that the connector is not unplugged.	The connector is plugged.
K9L-SC56B (only during operation)	Visually verify that there is no flaw or damage.	There is no flaw or damage.
	Visually verify that the connector is not unplugged.	The connector is plugged.
K9L-SC56C (only during operation)	Visually verify that there is no flaw or damage.	There is no flaw or damage.
	Visually verify that the connector is not unplugged.	The connector is plugged.
Power supply connection	Visually verify that the power supply cable is individually connected to commercial power supply.	The power supply cable is individually connected to commercial power supply.
Observation illumination lamp	Start this instrument. Select mydriatic mode for the photography mode, and turn the Observation light intensity control knob to 10 o'clock position. Confirm that the objective lens cap is removed. Place a hand in front of the objective lens and visually verify that the observation light illuminates the hand.	Observation light illuminates.

## 7 Maintenance and inspection

Objective lens	(Perform the following after inspecting the observation illumination lamp.) Turn the observation light intensity control knob to maximum, and visually verify the objective lens from oblique angle. Return the observation light intensity control knob to the 10 o'clock position after the confirmation.	No dust, debris, teardrop must be found.
Internal circuit	(Perform the following after inspecting the objective lens.) Make the instrument ready for photography according to the system configuration. Place a hand in front of the objective lens, and push the shutter button to verify that the flash light is emitted and the image is saved.	Flash light is emitted. The image is saved.

### 7.3 Daily cleaning

#### 7.3.1 Cleaning the objective lens

Images may show white shadow spots at the same places if the objective lens is contaminated with fingerprints, etc. Clean the objective lens according to the procedure below.

- 1) Turn on the power.
- 2) Set the photography mode to “mydriatic color” after the instrument has started up.
- 3) Set the observation illumination light intensity to maximum.
- 4) Blow off debris or dust using the attached blower.
- 5) When it is not cleaned by the procedure 4), moisten soft cloth or cleaning paper with cleaning solution made from ethyl alcohol and ether (1:1) and lightly wipe the lens starting from its center in a circular motion. Repeat this step several times.
- 6) If any soil is left out after cleaning according to the step 5), gently wipe off the soiled area with a cotton swab soaked with a little amount of water. If you have done this procedure, repeat the step 4).
- 7) Should you have any soil that cannot be removed by the steps above, contact Kowa or your Kowa dealer.



- Change the cleaning paper or the soft cloth to new one every time you wipe.



#### Important

- Cleaning the lens without removing dusts and debris when wiping may scratch the lens surface.
- Do not use chamois leather, silicon cloth etc.
- Carefully store and handle the flammable and combustible cleaning solution.

### 7.3.2 Cleaning and disinfection of the parts where patients contact the instrument (the forehead base, the chin rest, and the grip (optional accessory))

Wipe the forehead rest (including K9L-HR56 (optional accessory)), head bands, the chin rest (in case not using the chin paper), and the grip (K9L-GR56 (optional accessory)) with rubbing alcohol as soon as a patient completes the examination.

### 7.3.3 Cleaning the exterior and the LCD monitor

When exterior of this instrument other than described above is dirty, follow the steps below to clean it.

- 1) Wipe the surface with firmly squeezed dampened soft cloth.
  - 2) Wipe off the obstinate dirt with soft cloth, after dampening it in water or lukewarm water with diluted small amount of neutral detergent and firmly squeezing it.
- \* Do not use solvents such as thinner and benzene for cleaning the exterior.

When the LCD monitor is dirty, clean according to the following steps.

- 1) Wipe the LCD monitor with soft cloth, after dampening in water and firmly squeezing it
  - 2) Lightly wipe the LCD monitor with dry and soft cloth before the surface becomes completely dry.
- \* Do not wipe all the surface at a time, and finish area by area  
Water drops leave spots when they are dried.
- \* Do not use any liquid other than water or rubbing alcohol for cleaning the LCD monitor..

## 7.4 Replacement of consumables

### 7.4.1 Replacement of observation illumination lamps

- 1) Turn off the power switch and unplug the power plug from the electrical outlet.  
Wait for about 30 minutes and cool the lamp unit.
- 2) Loosen the lamp cover screws with a flat-head screwdriver, and remove the lamp cover.  
Hold a hand toward the internal black lamp cover, and touch it if you do not feel the heat to confirm it is cool enough.

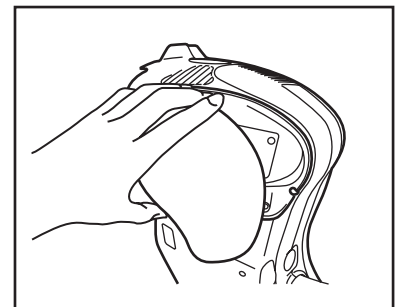

- 3) Loosen the inside lamp cover screws with a flat-head screwdriver. Loosen the 3 screws bit by bit, and remove the lamp cover when all screws are loosened. The observation illumination lamp comes out with the cover from the lamp house.

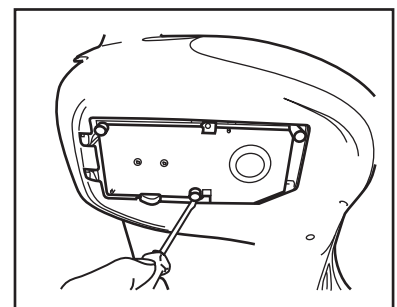

- 4) Hold a hand toward the illumination lamp, and lightly touch it if you do not feel the heat to confirm it is cool enough.

## 7 Maintenance and inspection

- 5) Hold the shade of the illumination lamp, pull the flat spring which fixes the lamp cover, and remove the lamp with the lamp socket from the lamp cover.

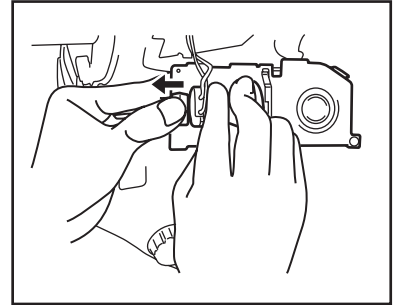

- 6) Hold the shade of the illumination lamp and pull it straight and slowly from the lamp socket

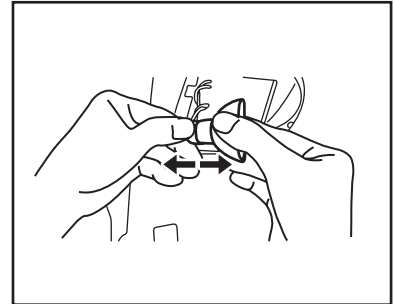

- 7) Attach a new illumination lamp to the lamp socket. Push tightly until the bottom of the lamp and the socket surface adheres.
- 8) Fix the lamp to the cover so that the hollow of the illumination lamp pedestal and the projection of the lamp and the shade are not misaligned.
- 9) Pay attention not to place the socket cable forward of the lamp shade when attaching the cover. Fix the cover by fastening the 3 screws successively with a flat-head screwdriver. Make sure there is no gap between the lamp house and the cover.
- 10) Insert the light source cover to the exterior of the optical head, and fix it with screws.



### Important

- Do not turn the illumination lamp.
- Push the illumination lamp to the end of the socket.
- When attaching the lamp cover, handle it so that the cable of the socket is not get caught or stressed.
- If the pedestal and the shade and the projection are misaligned, the lamp may be damaged.
- If you touch the lamp in the shade directly, it may shorten the life of the lamp.
- Pay attention not to drop the lamp or bump against the optical head.



### Warning



Unplug



Warning  
High-voltage

When replacing with new flash lamp and observation lamp, be sure to turn OFF the power switch before unplugging from the power outlet. Otherwise, there is a fear of electrical shock.



### Caution



Prohibitory



Warning  
High-temperature

Do not replace the flash lamp tube or observation light bulb immediately after use.

When replacing the flash tube or observation light bulb, be sure to turn OFF the main power switch and unplug it from the power outlet, and wait for 30 minutes or more.

Do not touch the flash lamp tube with your bare hands. Otherwise, the lamp may have a lower quantity of light and a shorter useful life.



### 7.4.2 Replacement of the lamp for photography

- 1) Turn off the power switch and unplug the power plug from the electrical outlet.  
Wait for about 30 minutes and cool the lamp unit.
- 2) Remove the internal black lamp cover when replacing the illumination lamp.

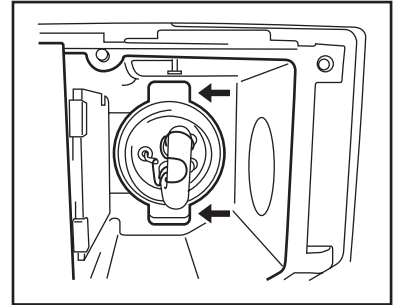

- 3) Insert the pulling tool attached to the replacement lamp for photography into the grooves at the top and the bottom of the lamp for photography in the lamp house.

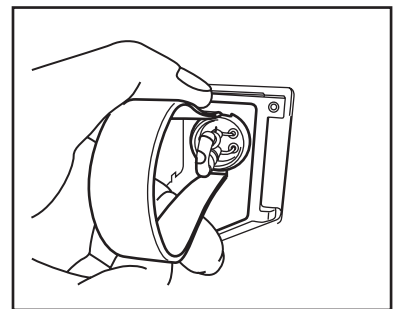

- 4) With the pulling tool inserted at the socket of the lamp for photography, pull it straight and slowly.
- 5) Hold the replacement lamp for photography with the pulling tool, and insert it into the lamp house straightly.

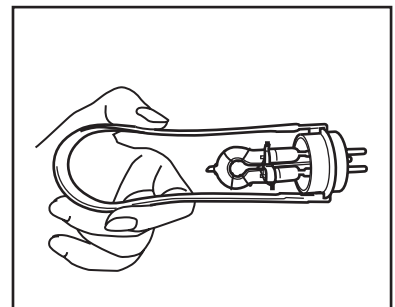

- 6) Take out the pulling tool from the lamp house.
- 7) Push the peripheral part of the lamp socket using the pulling tool or the protection cover of the replacement lamp for photography until the bottom of the lamp socket and the lamp house adhere to each other.
- 8) Attach the inside lamp cover and the light source cover as you replaced the illumination lamp.



### Important

- Do not turn the lamp for photography.
- Do not replace the lamp for photography directly holding it with hands. It may cause electrical shock or damage.
- Pay attention not to drop the lamp or bump against the optical head.



### Warning



Unplug



Warning  
High-voltage

When replacing with new flash lamp and observation lamp, be sure to turn OFF the power switch before unplugging from the power outlet. Otherwise, there is a fear of electrical shock.

## 7 Maintenance and inspection



**Caution**



Prohibitory



Warning  
High-temperature

Do not replace the flash lamp tube or observation light bulb immediately after use.

When replacing the flash tube or observation light bulb, be sure to turn OFF the main power switch and unplug it from the power outlet, and wait for 30 minutes or more.

Do not touch the flash lamp tube with your bare hands. Otherwise, the lamp may have a lower quantity of light and a shorter useful life.

### 7.4.3 Fuse replacement

- 1) Turn off the power switch and unplug the power plug from the electrical outlet.
- 2) Turn the fuse holder at the power supply counterclockwise with a flat-head screwdriver.
- 3) When the head of the old fuse comes out, hold it with a hand to pull it out.
- 4) Replace the fuse and place it in the fuse holder.
- 5) Press down the fuse holder with a flat-head screwdriver and turn the screwdriver clockwise.



**Warning**



Unplug



Warning  
High-voltage

When replacing with new fuses, turn OFF the power switch and unplug from the power outlet. Otherwise, there is a fear of electrical shock.

Use accessory or designated fuses. If other than designated ones should be used, there may occur failure or a fire on the equipment.



**Warning**



Obligatory

The fuse differs according to the voltage which is used. Make sure to use a correct fuse when replacing one.

### 7.4.4 List of consumables

Following is the list of consumables used on this instrument. Please contact Kowa or your Kowa dealer for purchase or any inquiry. It is recommended that you always stock the illumination lamp and the fuse for replacement.

Part name	Purchase order number
Flash lamp	K9L56 FU3A
Illumination lamp	K9L52 A26
Fuse	0218010.MXP

## 7.5 Regular inspection

---

In order to use this instrument safely over its useful life, we recommend you to have it inspected annually.

1. Records of each setting
2. External components and their installation
3. Optical components
4. Operations and functions of the components
5. Switching operations of photography mode
6. Observation image using Standard Model Eye (OD)
7. Photography using Standard Model Eye (OD)
8. Photography light intensity
9. Electrical safety test

Contact Kowa or your Kowa dealer for specific detail and cost of inspections.

Field angle	Mydriatic: 50°/30°	
	Non- mydriatic: 45°/27°	
Working distance	39mm (between the patient's eye and the front of the objective lens)	
Diopter compensation range of patient's eye	0	-12D - +13D
	-	-10D - -32D
	+	+10D - +35D
Focusing	Split luminous bars coincidence (with ON/OFF function)	
Working distance adjustment	Luminous dots indication (with ON/OFF function)	
Optical viewfinder (eyepiece) diopter compensation range	-8D - +5D	
Observation illumination light	Halogen lamp	
Photography flash lamp	Xenon flash lamp	
Horizontal optical head base moving distance	Lengthwise (coarse motion) --- 90mm (fine motion) --- approximately 17.5mm	
	Crosswise (coarse motion) --- 140mm (fine motion) --- approximately 17.5mm	
Vertical optical head base moving distance	30mm	
Tilting operation range	Elevation --- 11°, depression --- 15°	
Rotating arm operation range	30° each for left and right	
Power supply voltage	AC120V	
Power supply frequency	50/60Hz	
Power supply input	Normal: 250VA, Maximum: 1500VA	
Dimensions	394mm (W) x 562mm(D) x 724mm(H)	
Weight	39kg	

#### Compliance standard

- IEC 60601-1:1988+A1:1991+A2:1995
- IEC 60601-1-2:2007

#### Safety standard and classification

- According to the type of protection against electric shock  
(Class I device)
- According to the degree of protection against electric shock  
(Type B applied part)
- According to the type of protection against ingress of water as detailed in the current edition of IEC60529.  
(IPX0)
- According to the degree of safety of application in the presence of a flammable anaesthetic mixture with air or with oxygen or nitrous oxide.  
(Equipment not suitable for use in the presence of a flammable anesthetic mixture with air or with oxygen or nitrous oxide)
- According to the mode of operation.  
(continuous operation)

## 9.1 Folder structure and data format of the compact flash memory card

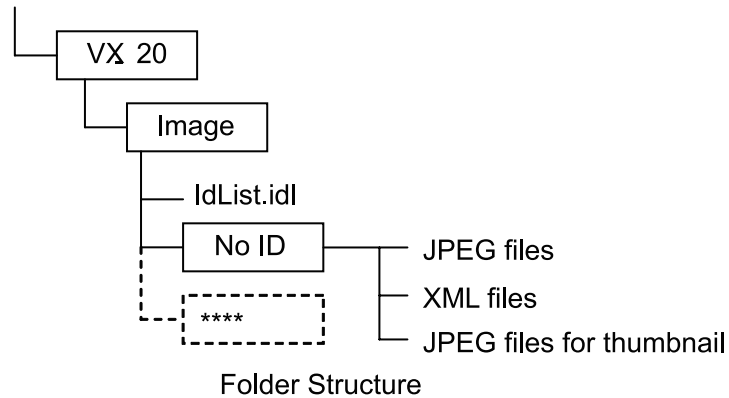

Image files (JPEG) and photography condition files (XML) are generated and saved in each of ID folders.

File name

[ID]\_[YYMMDD]\_[HHMMSS]\_KOWA\_[Photography type]\_[Photographed eye]\_[Timer elapsed time].Jpg  
 [ID]\_[YYMMDD]\_[HHMMSS]\_KOWA\_[Timer elapsed time].XML

ID:	Patient's ID
YYMMDD:	Date of photograph taken
HHMMSS:	Time of photograph taken
Photography type:	COLOR: Color photography
	REDFREE: Red free photography
	FA: Fluorescent photography
	AF: Autoflorescent photography
Photographed eye:	Right eye: R
	Left eye: L
Timer elapsed time:	Elapsed time on the timer at the time of FA photography 00MMSSmmm 01 or 02 is indicated if photography other than FA was performed.

## 9 Technical information

The structure of the photography condition files is as shown below.

```
<?xml version="1.0" encoding="UTF-8"?>
<?xml-stylesheet type="text/xsl" href="Fundus_Stylesheet.xsl"?>
<Ophthalmology xmlns:xsi="http://www.w3.org/2001/XMLSchema-instance"
xmlns:nsCommon="http://www.joia.or.jp/standardized/namespaces/Common"
xmlns:nsFUNDUS="http://www.joia.or.jp/standardized/namespaces/Fundus"
xsi:schemaLocation="http://www.joia.or.jp/standardized/namespaces/Common Common_schema.xsd
http://www.joia.or.jp/standardized/namespaces/Fundus Fundus_schema.xsd">
  <nsCommon:Common>
    <nsCommon:Company>KOWA</nsCommon:Company>
    <nsCommon:ModelName>VX-20</nsCommon:ModelName>
    <nsCommon:MachineNo> [11-digit serial number] </nsCommon:MachineNo>
    <nsCommon:ROMVersion></nsCommon:ROMVersion>
    <nsCommon:Version>1.0</nsCommon:Version>
    <nsCommon:Date>YYYY-MM-DD</nsCommon:Date>
    <nsCommon:Time>HH:MM:SS</nsCommon:Time>
    <nsCommon:Patient>
      <nsCommon:No.> [4-digit test number] </nsCommon:No.>
      <nsCommon:ID> [Patient's ID] </nsCommon:ID>
      <nsCommon:FirstName> </nsCommon:FirstName>
      <nsCommon:MiddleName></nsCommon:MiddleName>
      <nsCommon:LastName></nsCommon:LastName>
      <nsCommon:Sex></nsCommon:Sex>
      <nsCommon:Age></nsCommon:Age>
      <nsCommon:DOB></nsCommon:DOB>
      <nsCommon:NameJ1></nsCommon:NameJ1>
      <nsCommon:NameJ2></nsCommon:NameJ2>
    </nsCommon:Patient>
    <nsCommon:Operator>
      <nsCommon:No.></nsCommon:No.>
      <nsCommon:ID></nsCommon:ID>
    </nsCommon:Operator>
    <nsCommon:Parts> [2-digit maintenance code for Kowa] </nsCommon:Parts>
  </nsCommon:Common>
  <nsFUNDUS:Measure type="FUNDUS">
    <nsFUNDUS:FUNDUS>
      <nsFUNDUS:List No="1">
        <nsFUNDUS:ImageType> [Photography type] </nsFUNDUS:ImageType>
        <nsFUNDUS:AcquisitionDate> YYYY-MM-DD </nsFUNDUS:AcquisitionDate>
        <nsFUNDUS:AcquisitionTime> HH:MM:SS </nsFUNDUS:AcquisitionTime>
        <nsFUNDUS:Timer> [Timer elapsed time 00MMSSmmm] </nsFUNDUS:Timer>
        <nsFUNDUS:HorizontalFieldOfView unit="deg"> [Field angle] </nsFUNDUS:HorizontalFieldOfView>
        <nsFUNDUS:ImageLaterality> [Photographed eye] </nsFUNDUS:ImageLaterality>
        <nsFUNDUS:PixelSpacing unit="mm"></nsFUNDUS:PixelSpacing>
        <nsFUNDUS:FileName> [Image file name] </nsFUNDUS:FileName>
      </nsFUNDUS:List>
    </nsFUNDUS:FUNDUS>
  </nsFUNDUS:Measure>
  <nsStatus:Status>
    <nsStatus:ImageTypeEx>[Photography type extension]</nsStatus:ImageTypeEx>
    <nsStatus:FlashIntensity>[Flash intensity]</nsStatus:FlashIntensity>
    <nsStatus:ISOsensitivity>[Sensitivity]</nsStatus: ISOsensitivity >
    <nsStatus:Apperture>[Aperture size]</nsStatus:Apperture>
    <nsStatus:Fixation>[Fixation target position]</nsStatus:Fixation>
    <nsStatus:Diopter>[Diopter compensation]</nsStatus:Diopter>
    <nsStatus:Pupil>[Pupil diameter]</nsStatus:Pupil>
    <nsStatus:ImageSize>[Image size]</nsStatus:ImageSize>
    <nsStatus:ImageLevel>[Compression rate]</nsStatus:ImageLevel>
  </nsStatus:Status>
</Ophthalmology>
```

## 9.2 Number of photographs taken using the supplied memory card

The number of photographs you may take using the supplied 2-GB memory card depends on the photography mode as well as size and compression rate that are set according to 5.2.3. Image quality/color. The table below shows approximate number of photographs that may be taken with each setting.

Size	Compression rate	Number of photographs	
		Other than FA	FA
S	Basic	5800	18500
	Normal	2200	
	Fine	1500	
M	Basic	3400	9300
	Normal	1150	
	Fine	800	
L	Basic	2200	5350
	Normal	700	
	Fine	500	

\* Based on the number of photographs taken with a model eye. The file sizes of actual photographs vary. Please note the above numbers are only approximate numbers.

## 9.3 File format and name of the files generated in the Network connection setting

In the Network connection setting, image files (JPEG) and photography condition files (XML) are generated and saved in a designated folder.

The rules on assigning a file name and the file structure of photography condition files are the same as those of the compact flash memory card.

“**Caution** – The light emitted from this instrument is potentially hazardous. The longer the duration of exposure, the greater the risk of ocular damage. Exposure to light from this instrument when operated at maximum intensity will exceed the safety guideline after 1874 pulses for image capturing light, 206 min for illumination light, 30 min for working dots lights(visible), 7 hour for working dots light(IR), 43 hour for focus dots light(visible), 43 hour for focus dots light(IR), 7 hour for internal fixation light(red), 7 hour for internal fixation light(green), 440662 pulses for external fixation light(red), 536139 pulses for external fixation light(green).”

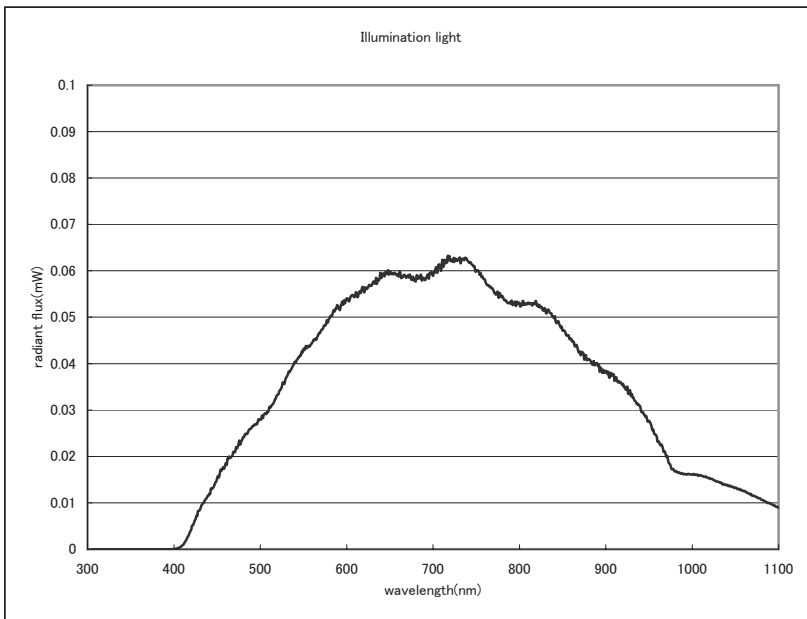
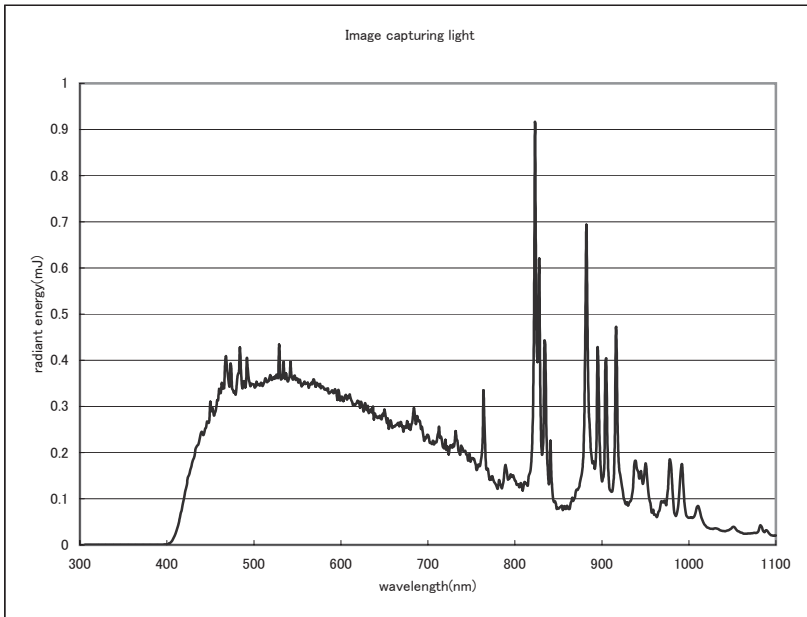



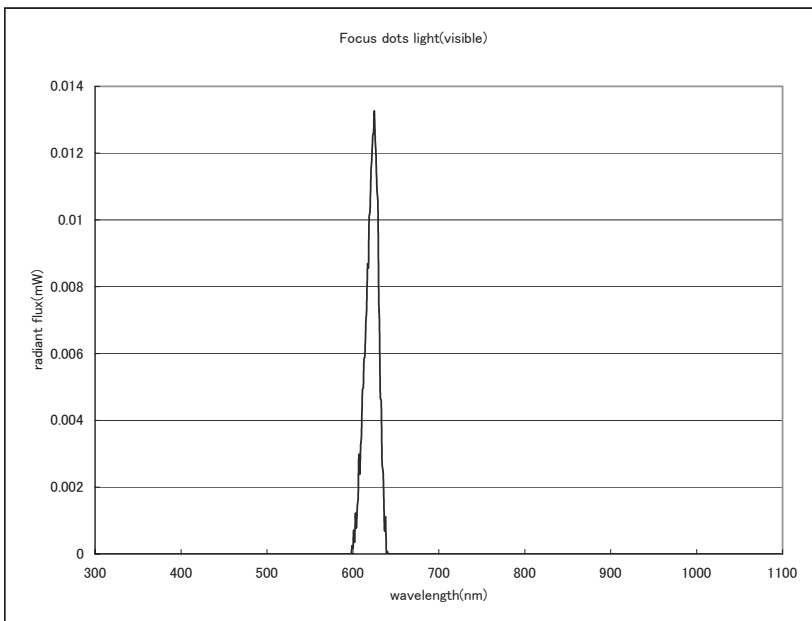
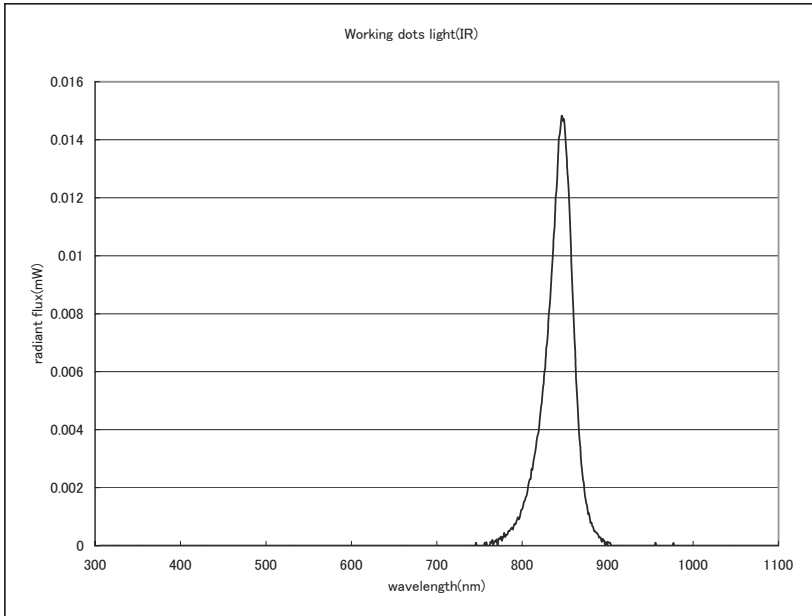
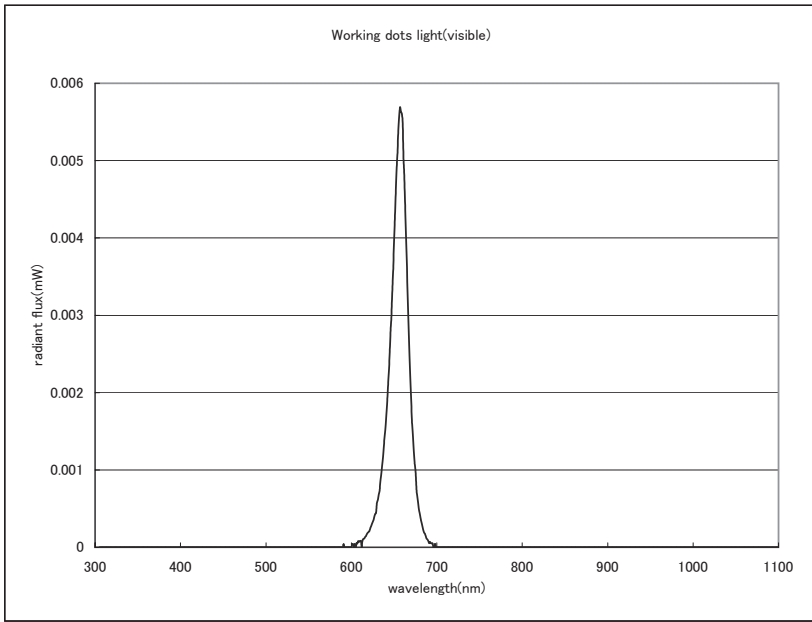

# 10 Light Hazard (ISO 15004-2)

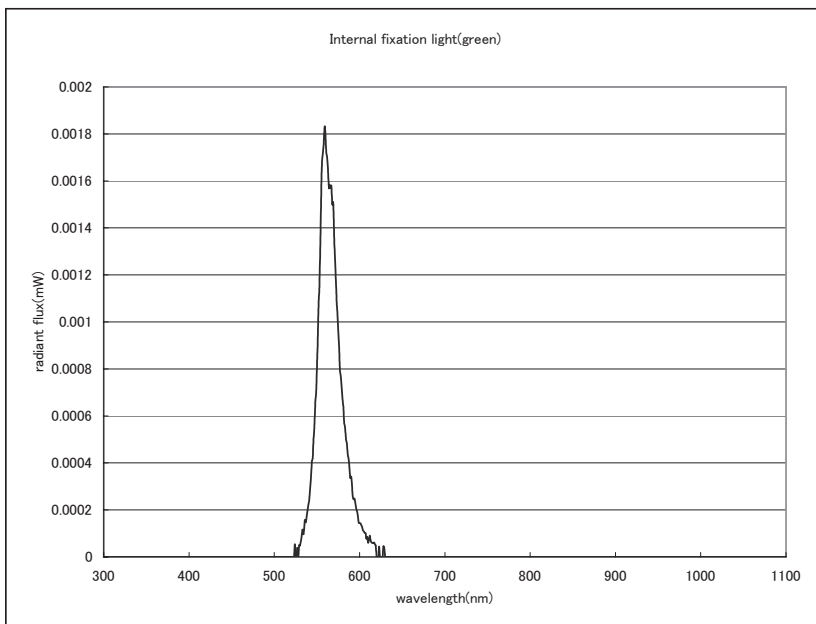
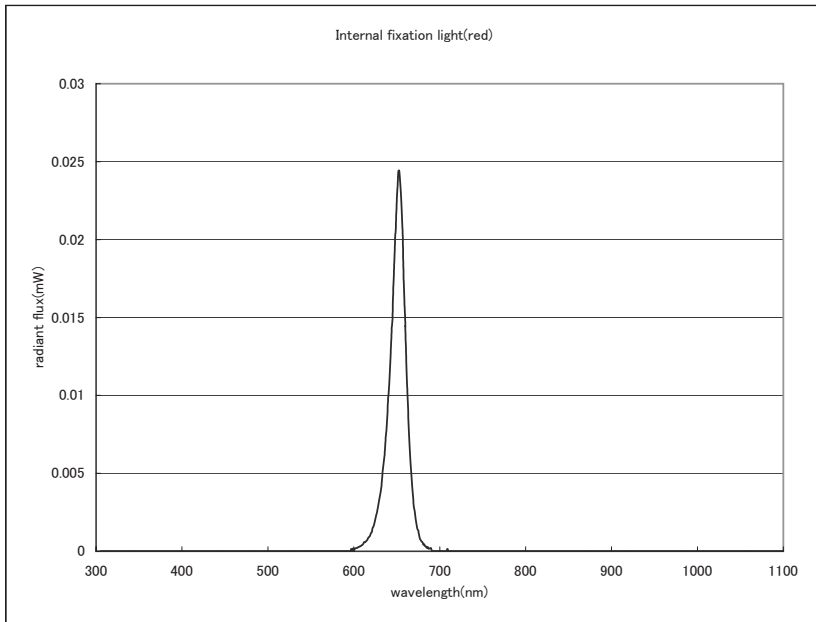
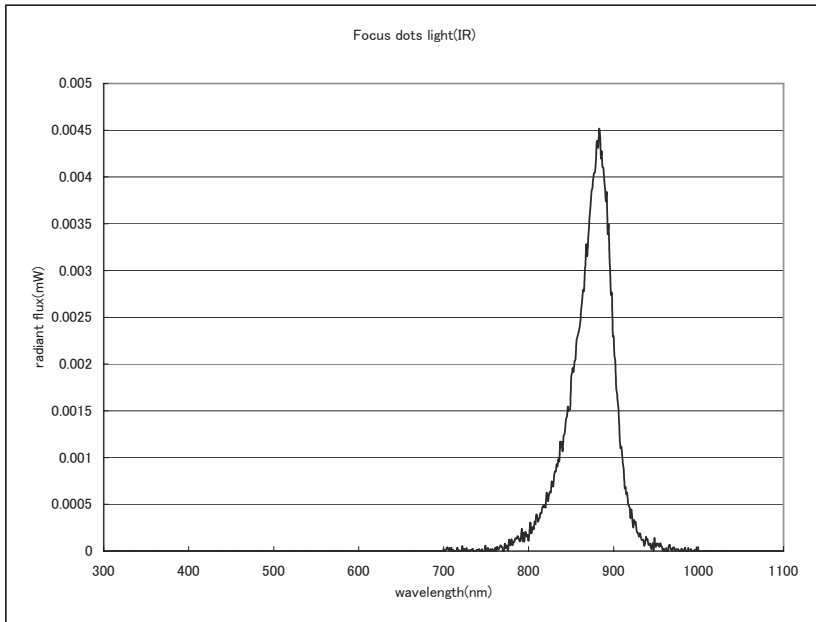

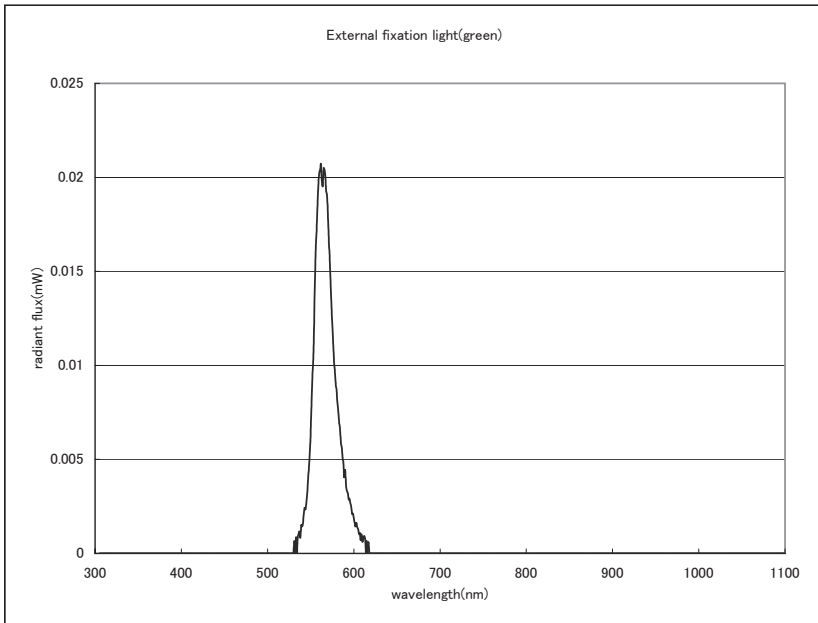
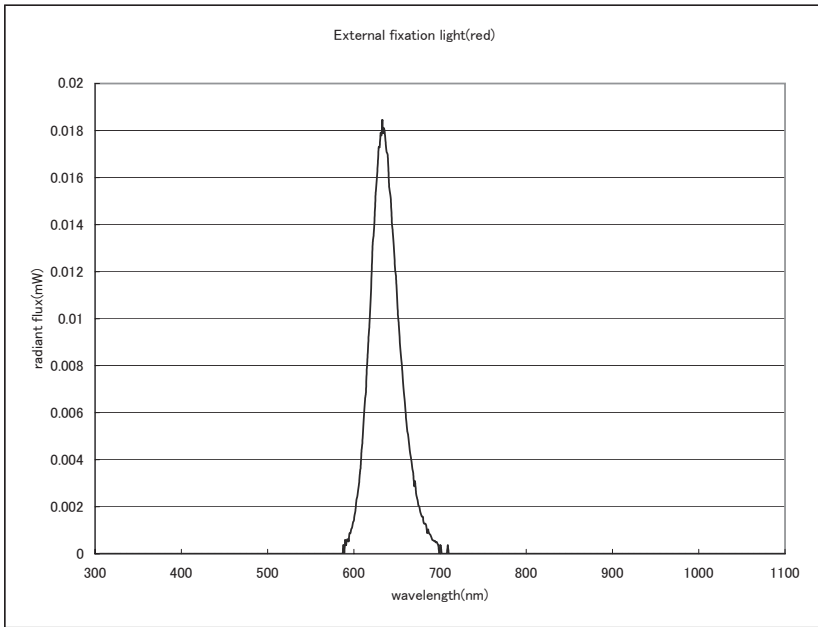

This instrument is a medical electrical instrument. Medical electrical instruments are required special attention to the electromagnetic compatibility (EMC). The following section describes the EMC and precautions regarding this instrument. When installing or using this instrument, read the description carefully and follow the directions described.

(The EMC of this instrument was tested based on IEC60601-1-2.)

1. Please note that portable- or mobile-type radio frequency communication devices (RF communications instrument) may adversely affect this instrument resulting in malfunctioning.
2. The electromagnetic compatibility (EMC) of this instrument was tested with the options and accessories shown below.

Since using an option or accessory other than those specified may cause malfunctioning of this instrument due to interferences of other device or cause malfunctioning of other device, use only the options or accessories specified for this instrument.

- Power cable: 3 m maximum
  - USB cable (Type A – B): 5 m maximum
  - USB cable (Type A – Mini-B): 3 m maximum
  - USB cable (Type A – Mini-B): 5 m maximum
  - LAN cable: 5 m maximum
  - Coaxial cable: 5 m maximum
  - Personal computer: CE Marking and VCCI approved PC
3. This instrument is not designed such that it can be used adjacent to other instrument or placing one on top of another. Therefore, do not apply such use. Nevertheless, if such use is inevitable, it is necessary to monitor constantly if the instrument is functioning normally after such use has been adopted.
  4. We specified the functions listed in the table below as the basic performance of this instrument to determine EMC of this instrument.

Function	Essential performance
Photography functions	Adjusting observation light intensity
	Adjusting photography light intensity
	Emission of photography light
Functions concerning operation of the instrument	Chin rest vertical movement
	Field angle selection
	Switching of ring slit
	Switching of diopter compensation
	Switching of optical viewfinder (eyepiece), switching of black and white camera
	Captured image output
	Touch panel input
LCD monitor display functions	LCD monitor display

**[Compliance verification and guidance]**

Guidance and manufacturer's declaration - electromagnetic emissions		
KOWA VX-20 is intended for use in the electromagnetic environment specified below. The customer or the user of KOWA VX-20 should assure that it is used in such an environment.		
Emissions test	Compliance	Electromagnetic environment - guidance
RF emissions CISPR 11 EN 55011	Group 1	KOWA VX-20 uses RF energy only for its internal function. Therefore, its RF emissions are very low and are not likely to cause any interference in nearby electronic instrument.
RF emissions CISPR 11 EN 55011	Class B	KOWA VX-20 is acceptable in all types of facilities without any limitation to the electrical supply network connected to KOWA VX-20.
Harmonic emissions IEC 61000-3-2 EN 61000-3-2	Class A	
Voltage fluctuations/ flicker emissions IEC 61000-3-3 EN 61000-3-3	Complies	

Guidance and manufacturer's declaration - electromagnetic immunity			
KOWA VX-20 is intended for use in the electromagnetic environment specified below. The customer or the user of tKOWA VX-20 should assure that it is used in such an environment.			
Immunity test	IEC60601 test level	Compliance level	Electromagnetic environment - guidance
Electrostatic discharge(ESD) IEC 61000-4-2 EN 61000-4-2	±6kV contact ±8kV air	±6kV contact ±8kV air	Floors should be wood, concrete or ceramic tile. If floors are covered with synthetic material, the relative humidity should be at least 30%.
Electrical fast transient/burst IEC 61000-4-4 EN 61000-4-4	±2kV for power supply lines ±1kV for input/output lines	±2kV for power supply lines ±1kV for input/output lines	Mains power quality should be that of a typical commercial or hospital environment.
Surge IEC 61000-4-5 EN 61000-4-5	±1kV differential mode ±2kV common mode	±1kV differential mode ±2kV common mode	Mains power quality should be that of a typical commercial or hospital environment.
Voltage dips, short interruptions and voltage variations on power supply input lines IEC 61000-4-11 EN 61000-4-11	<5% $U^T$ (>95% dip in $U^T$ ) for 0.5 cycle  40% $U^T$ (60% dip in $U^T$ ) for 5 cycles  70% $U^T$ (30% dip in $U^T$ ) for 25 cycles  <5% $U^T$ (>95% dip in $U^T$ ) for 5 sec	<5% $U^T$ (>95% dip in $U^T$ ) for 0.5 cycle  40% $U^T$ (60% dip in $U^T$ ) for 5 cycle  70% $U^T$ (30% dip in $U^T$ ) for 25 cycle  <5% $U^T$ (>95% dip in $U^T$ ) for 5 sec	Mains power quality should be that of a typical commercial or hospital environment. If the user of KOWA VX-20 requires continued operation during power mains interruptions, it is recommended that KOWA VX-20 be powered from an uninterruptible power supply.
Power frequency (50/60Hz) magnetic field IEC 61000-4-8 EN 61000-4-8	3 A/m	3 A/m	Power frequency magnetic fields should be at levels characteristic of a typical location in a typical commercial or hospital environment.
NOTE $U^T$ is the a.c. mains voltage prior to application of the test level.			

## 11 Electromagnetic compatibility (IEC60601-1-2)

Guidance and manufacturer's declaration - electromagnetic immunity			
KOWA VX-20 is intended for use in the electromagnetic environment specified below. The customer or the user of KOWA VX-20 should assure that it is used in such an environment.			
Immunity test	IEC 60601 test level	Compliance level	Electromagnetic environment– guidance
Conducted RF IEC 61000-4-6 EN 61000-4-6	3 Vrms 150 kHz to 80 MHz	3 Vrms	Portable and mobile RF communications instrument should be used no closer to any part of KOWA VX-20, including cables, than the recommended separation distance calculated from the equation applicable to the frequency of the transmitter.  Recommended separation distance $d=1.2 \sqrt{P}$  $d=1.2 \sqrt{P}$ 80 MHz to 800 MHz $d=2.3 \sqrt{P}$ 800 MHz to 2.5 GHz
Radiated RF IEC 61000-4-3 EN 61000-4-3	3 V/m 80 MHz to 2.5 GHz	3 V/m	where P is the maximum output power rating of the transmitter in watts (W) according to the transmitter manufacturer and d is the recommended separation distance in metres (m).  Field strengths from fixed RF transmitters, as determined by an electromagnetic site survey <sup>a</sup> , should be less than the compliance level in each frequency range <sup>b</sup> .  Interference may occur in the vicinity of instrument marked with the following symbol:  
NOTE 1 At 80MHz and 800MHz, the higher frequency range applies. NOTE 2 These guidelines may not apply in all situations. Electromagnetic propagation is affected by absorption and reflection from structures, objects and people.			
a Field strengths from fixed transmitters, such as base stations for radio (cellular/cordless) telephones and land mobile radios, amateur radio, AM and FM radio broadcast and TV broadcast cannot be predicted theoretically with accuracy. To assess the electromagnetic environment due to fixed RF transmitters, an electromagnetic site survey should be considered. If the measured field strength in the location in which KOWA VX-20 is used exceeds the applicable RF compliance level above, KOWA VX-20 should be observed to verify normal operation. If abnormal performance is observed, additional measures may be necessary, such as re-configuring or relocating KOWA VX-20 b Over the frequency range 150kHz to 80MHz, field strengths should be less than 3 V/m.			

Recommended separation distances between portable and mobile RF communications instrument and KOWA VX-20			
KOWA VX-20 is intended for use in an electromagnetic environment in which radiated RF disturbances are controlled. The customer or the user of KOWA VX-20 can help prevent electromagnetic interference by maintaining a minimum distance between portable and mobile RF communications instrument (transmitters) and KOWA VX-20 as recommended below, according to the maximum output power of the communications instrument.			
Rated maximum output power of transmitter W	Separation distance according to frequency of transmitter m		
	150 kHz to 80 MHz $d=1.2 \sqrt{P}$	80 MHz to 800 MHz $d=1.2 \sqrt{P}$	800 MHz to 2.5 GHz $d=2.3 \sqrt{P}$
0.01	0.12	0.12	0.23
0.1	0.37	0.37	0.74
1	1.2	1.2	2.3
10	3.7	3.7	7.4
100	12	12	23
For transmitters rated at a maximum output power not listed above, the recommended separation distance d in metres (m) can be estimated using the equation applicable to the frequency of the transmitter, where P is the maximum output power rating of the transmitter in watts (W) according to the transmitter manufacturer. NOTE 1 80MHz and 800MHz, the separation distance for the higher frequency range applies. NOTE 2 These guidelines may not apply in all situations. Electromagnetic propagation is affected by absorption and reflection from structures, objects and people.			





Technology for Life Science

 *Kowa Company, Ltd.*

**World Sales Headquarters**

4-14, Nihonbashi-honcho 3-chome, Chuo-ku, Tokyo 103-8433 Japan  
Phone : 81(3) 3279-7639  
Facsimile : 81(3) 3279-7541  
URL: <http://www.kowa.co.jp/e-life/>



**Kowa Company, Ltd. Hamamatsu Factory**

3-1, Shinmiyakoda 1-chome, Kita-ku, Hamamatsu city, Shizuoka Pref., 431-2103 Japan

***Kowa Optimed, Inc.***

20001 So.Vermont Ave.Torrance, CA 90502, U.S.A.  
Phone: 1(310)327-1913  
Facsimile: 1(310)327-4177  
URL : <http://www.kowa-usa.com/>

Printed on recycled paper.

© 2011 Kowa Company, Ltd. All rights reserved.  
K9L56 V1.0K 110629 MS  
Printed in Japan